

MORSE... LINKS YOU TO A WORLD OF MAXIMUM PERFORMANCE, MINIMUM COSTS

MORSE® Roller And Other Chain Products Provide Your Strongest Link To Savings

No other company offers all these exclusive cost-saving features and benefits in reliable chain drives. You can select from a full range of pre-stressed roller chain: standard and heavy series, single and multiple strand; custom conveyor chain with a variety of attachments; specialty chain; HV and inverted tooth and SC Silent Chain, plus many more specialized designs; (See MORSE CHAIN Table below).

All chain manufactured to precision standards utilizing world-class technology. The designed-in, built-in quality and superior manufacturing methods produce Morse brand chains with higher horsepower ratings. This means you can design a more compact new drive, or benefit from a higher service factor on an existing one... obtain longer chain/drive life with reduced maintenance... reduce original purchase price and overall costs. The potential for savings is significant. Check out these top-quality features... resultant benefits.

Perfectly round bushings
improve surface control-less wear, longer life.

Solid rollers
of optimal wall thickness, finer finish, more impact strength.

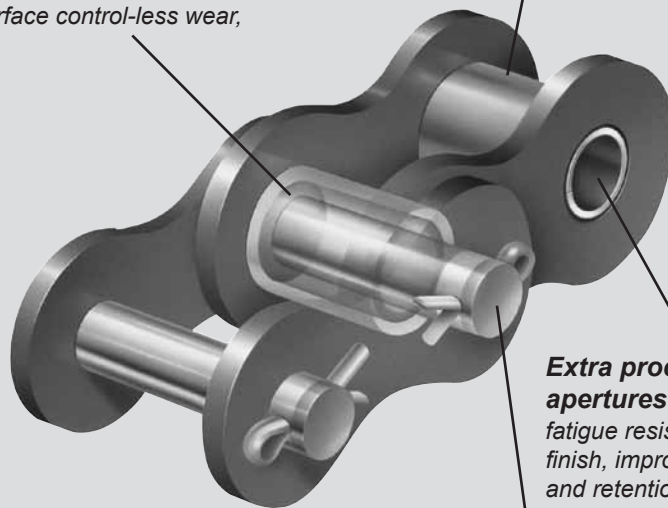

Extra processing of link apertures
fatigue resistant surface finish, improved pin contact and retention.

Tapered end pins
smooth trouble-free assembly, helps prevent link-plate damage.

MORSE CHAIN	
Single Strand	Pitch
Standard Series.....	25-200
Heavy Series.....	60-200
High Strength.....	60-200
Lubed For Life.....	40-80
Standard Attachment.....	25-160
Double Pitch Conveyor	
Standard Roller.....	2040-2120
Large Roller.....	2042-2122
Double Pitch Attachment.....	C2040-C2122
Other	
Leaf.....	BL4-BL16
Rollerless Hoist.....	65-105
Wrench.....	50
Agricultural.....	80
HV Inverted Chain.....	3/8-2
SC Silent Chain.....	3/16-1
Stainless Steel.....	25-80
Nickel Plated.....	35-60
Pre-Lubricated.....	40-80
MULTI FLEX	100-200
Multiple Strand	
Standard	
Double, Triple, Quadruple.....	35-200
Quintuple, Sextuple, Octuple.....	60-160
Heavy	
Double, Triple, Quadruple.....	60-200
Quintuple, Sextuple.....	60-160
Pre-Lubricated Double.....	40-50

BROWNING® ROLLER CHAIN	
Standard Series	Pitch
Single.....	35-160
Double.....	35-160
Triple.....	35-80



Morse® Attachment Chain is offered in a significant breadth of line — 35 to 160, C2040 to C2122 and with excellent custom design capabilities.

*Morse is a registered trademark of Borg-Warner Corporation, used herein under exclusive license.



BROWNING...OFFERS THE WORLD'S LARGEST SELECTION OF APPLICATION "MATCHED, SHAFT-READY SPROCKETS"

Maximum Drive Efficiency At The Lowest Evaluated Cost.

You can choose from the world's largest selection of high-quality, shaft-ready sprockets to solve all your application problems. In-stock hardened sprockets, a Browning specialty, are guaranteed to last at least twice as long as the standard (unhardened) mild steel sprockets they replace. The result is increased chain life and reduced downtime.

Additionally, you have the industry's broadest selection of sprocket mounting choices. Sprockets are available with three types of bushings to ensure secure mounting to shaft:

- **BROWNING SPLIT TAPER®** Bushing — available in inch and metric sizes, as well as with spline bores; bore range 1/4-10".
- **Q-D®** Bushing in 1/16 inch increments and metric sizes.
- **TAPER BORE** in the same configurations.
- Finished Bore Sprockets are available with Hardened Teeth and 2 Setscrews for driver size sprockets, (30 teeth and smaller).
- Minimum Bore Sprockets are provided from stock to allow for our customers, requirements for simple modifications with same day delivery service.
- Browning continues to provide custom sprockets for a variety of applications up through 60" diameters.
- The combination of the above provides one of the broadest selections of stock sprockets in the industry.



BROWNING SPLIT TAPER® Bushing



Q-D® Bushing

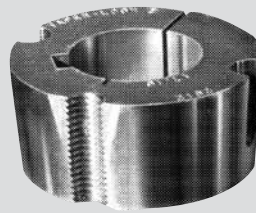

TAPER BORE Bushing



Bushing type hardened sprocket and Browning's exclusive warranty (to last twice as long as a standard sprocket).



STANDARD & HARDENED SPROCKETS

	No. Strands	Pitch Range	Bore Range	Hardened Teeth
Bushing Type	1	35-200	3/8-5"	Up to 40 teeth
	2	35-200	3/8-5"	
	3	35-160	1/2-5"	
	4	80-160	1-5"	
Finished Bore	1	35-100	3/8-2 7/16"	Up to 30 teeth
Type B Min. Bore	1	25-240	1/4-6 3/4"	
	2	35-240	1/2-8 1/4"	
	3	35-200	1/2-8 3/8"	
	4	35-200	1/2-9 1/4"	
Type A Steel Plate	1	25-240		
OTHER SPROCKETS				
Double Single Sprockets		40-100	3/8-3 3/4"	All
Extended Pitch Sprockets		2040-2080	3/8-2 11/16"	
		2040-2082	5/8-3"	
		2102	1 1/4-3"	
Shear Pin Sprockets & Hubs		40-160	3/8-5"	
Torque Limiters & Sprockets		35-80	1/2-2 1/2"	

To ensure optimum quality and reliability, Browning uses precision gear checking quality techniques in manufacturing these sprockets.



Standard series roller chain

Made to ANSI B29.1 specifications. Available in single to octuple widths - pages G14 to G17.



Heavy series roller chain

Made to ANSI B29.1 specifications. Similar to standard series roller chain, but having plate thickness of the next regular pitch. Available in sizes 60H and larger in single to sextuple width - pages G14 to G16.



Standard series attachment roller chain

Made to ANSI B-29.1 specifications. Available in sizes #35 through #160 with extended pin, B-1, B-2, S-1, and S-2 attachments - pages G31 to G33.



Double pitch drive chains

Made to ANSI B-29.3. Available in figure 8 contour sizes 1" pitch to 2" pitch pages G34 and G35.



Double pitch conveyor chains

Made to ANSI B-29.4 specification. Available in 1" pitch to 3" pitch in both standard roller and large roller - page G36.



Double pitch conveyor attachment chains

Made to ANSI B-29.4 specifications. Available in 1" pitch to 3" pitch in both standard and large rollers with extended pin. B-1, B-2, S-1, and S-2 attachments - pages G37 and G38.



Leaf chain

Made to ANSI B-29.8 specifications. Made of roller chain type links and riveted pins to utilize maximum strength for given widths. Used as tension linkage or lifting device at slow speeds. Available in various lacings in 1/2" pitch to 2" pitch page - G42.



Rollerless hoist chains

Made of same construction as standard roller chains except rollers have been omitted. Available in 3 sizes - 3/4", 1", and 1 1/4" pitches - page G43.

Corrosion resistant chains

A choice of nickel plated for mildly corrosive environments to stainless steel for the more severe conditions. Available in 1/4", 3/8", 1/2", 5/8", 3/4", and 1" pitches on page G44 to G47.



Sintered bushing chain

Made for slow speed applications where external lubrication is prohibited. Available in 1/2", 5/8", 3/4", and 1" pitches on pages G48 and G49.



High strength chains

For application where maximum strengths are required. Chains will fit standard ANSI sprockets. Available with heavy sidebars in 3/4" through 2 1/2" pitches on page G50.



Wrench chain

Made same as leaf chain except with extended pins each side. Available in 5/8" pitch - page G50.

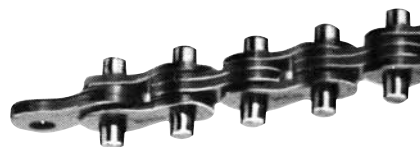

Agricultural chains

Made to ANSI B29.1 specifications, #80 sticker chain used primarily in the Agricultural industry on page G50.

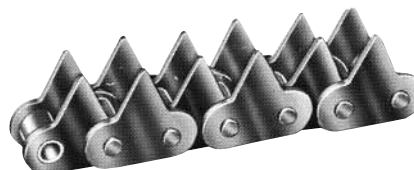

HV

A Morse exclusive where heavy loads - to 6,000 horsepower are to be transmitted at moderate to high speeds over 10,000 feet per minute, and compact design is important. Offered in 3/8", 1/2", 3/4", 1", 1 1/2", and 2" pitches. Pages I-1 through I-20.

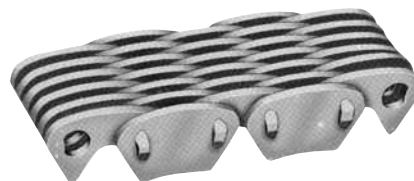

Silent chain

Made to ANSI B29.2 specifications. Designed to handle moderate speed application. Available in 3/16", 3/8", 1/2", 3/4", and 1" pitches. Pages I-20 through I-34.



MORSE® chain power transmission spectrum

Morse offers a complete line of chain drives to meet the challenge of industry today—as ever-increasing horsepowers, higher operating speeds, and ultra-precision timing are demanded by more and more modern chain users. Morse offers Roller Chain for high capacity at low to moderate speeds and HV Chain for highest capacity at high speeds. Silent Chain fills the need for smooth, silent drives at low to moderate speeds.

Note the typical power comparison shown in Fig. 1. Roller Chain climbs straight and rapidly to a peak in the RPM's where gas engines and electric motors are the prime movers. HV picks up just after Roller Chain has passed its peak and climbs gradually to a peak in the high speed diesel and gas turbine ranges. Silent chain fills out the spectrum, offering low to moderate horsepowers for applications where the speed requirement is marginal for roller chain.

Roller Chain and Silent Chain both offer the advantages of ANSI interchangeability and "off-the-shelf" delivery of the complete drive. HV offers the unique ability to carry tremendous loads at speeds far exceeding the capabilities of any other chain drive.

For speed, horsepower capacity, difficult drive conditions or just good economics, specify "Morse" for the optimum chain drive.

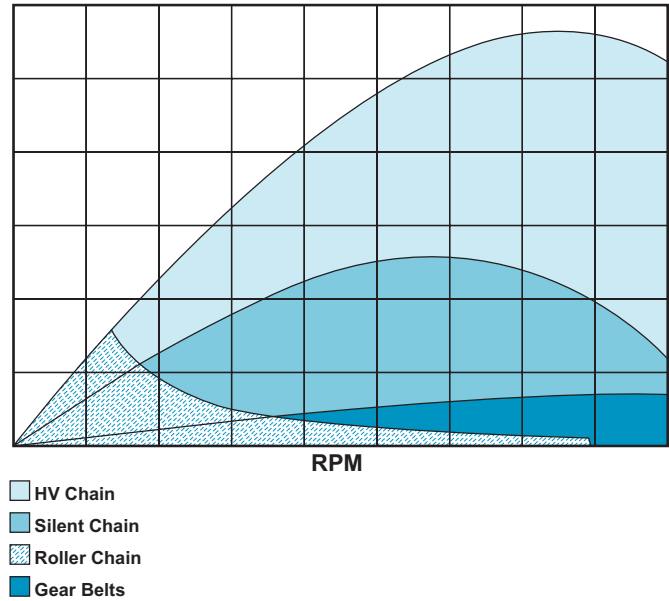

Fig. 1 Power Comparison

HV chain "SECTION I"

Morse® HV chain is ideal for applications where heavy loads—50 to 6000 horsepower—are to be transmitted at moderate to high speeds—over 10,000 feet per minute, and where compact design is important. Offered in 3/8", 1/2", 3/4", 1", 1 1/2", 2" pitch sizes, HV is a highly refined inverted tooth chain combining the smoothness of a belt with the compactness, economy, and long service life of a chain drive.

HV features a pin and rocker joint which, through its rolling action, reduces friction and provides pitch elongation. The result is the reduction of damaging chordal action and a significant increase in horsepower capacity.

HV links have more metal at the aperture, a lower crotch, and are shot peened and prestressed for greater load carrying capacity.

HV offers three times the horsepower capacity of silent chain and a greater speed range. At higher speeds where roller chain capacity drops off rapidly, HV capacity is increasing. HV therefore, has a significant dollar advantage in many instances. HV should be considered for all power transmission requirements involving high speed prime movers such as diesel engines or gas turbines. Morse HV is your best buy for high capacity, high speed mechanical power transmission.

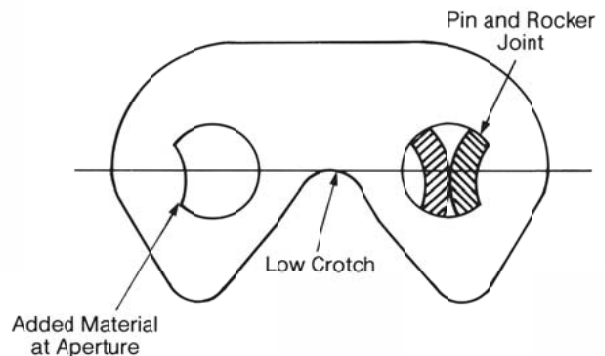

Silent chain "Section I"

Morse® SC Chain is available in American National Standards Institute SC pitches from 3/16" to 1". For all power transmitting SC chain except 3/16" pitch, Morse uses a special rocker-pin joint. This joint is superior for power transmission because the motion between the rocker-pin parts during articulation is a rolling action rather than the high friction, power wasting sliding action that is characteristic of round pin joints. This joint design therefore minimizes heat and wear rates and makes possible maximum speed, loads, and life for Morse silent chain. In 3/16" pitch, these undesirable factors are minimal, and a round pin joint is utilized to facilitate manufacture and assembly. In motion transmitting chains such as duplex chain, Morse has available a round pin joint to allow backbending.

Applications range from home movie projector drives to small turbine drives.

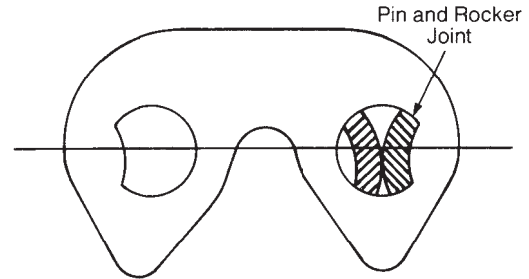

Roller chain

Morse® Roller Chain covers fractional to 3000 horsepower applications, and transmits power up to a speed of 10,000 feet per minute depending on chain size. It is offered in ANSI standard pitches from #25 to #240.

Since endurance limit of the sideplates dictates the maximum capacity of roller chain, Morse has implemented engineering and manufacturing effort to strengthen the sideplates against fatigue and help increase the endurance limit of Morse roller chain (see Fig. 2). Combining contour design and precision blanking, ballizing and shot-peening, and the latest methods of heat treatment and assembly, Morse markets roller chain featuring greater resistance and increased endurance limit. This results in the high capacity peaks presented in the curves.

At speeds beyond the curve peaks, roller chain capacity is limited by roller impact (see Fig. 3). To help prevent roller breakage and early chain failure, Morse shot-peens its rollers to create a favorable state of compressive residual stress on the surface and eliminate surface cracks and blemishes.

The round pin joint inherent in roller chain design limits the speed range of roller chain due to joint galling (see Fig. 3) caused by friction between the pin and bushing as the joint articulates at high speeds.

As the chain pitch gets larger, the maximum permissible speed decreases; for example, using 25 tooth sprockets, #40 attains speeds to 6770 f.p.m. whereas #80 attains speeds to

5000 f.p.m. For the joint design, Morse features equal load distribution over a large projected bearing area—minimizing unit load and wear rate. The heavy-walled bushings have maximum resistance to fatigue during operation and to distortion during assembly into side plates under heavy press fits. The Morse pins are hardened and ground to rigid tolerances to assure uniform contact with the mating bushing surface.

Roller Chain should be used for application requiring high horsepower at lower speeds. It is usually more economical to employ a multiple strand Roller Chain than HV for extremely high capacity applications under 3000 f.p.m. Within its capacity and speed ranges, Morse roller chain is your best purchase.

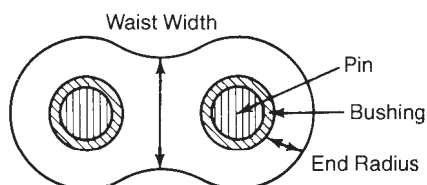

Fig. 2

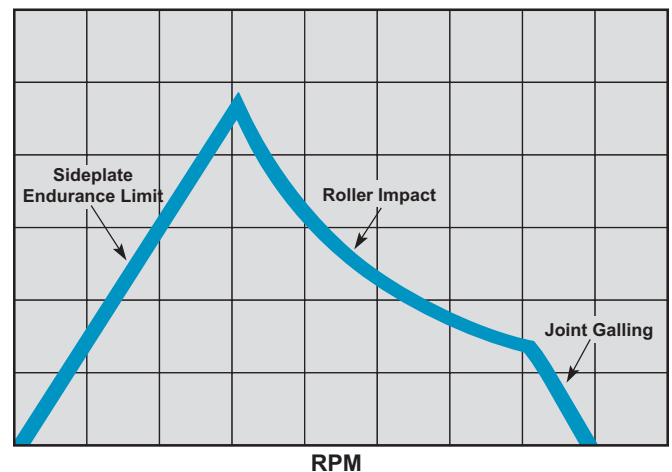
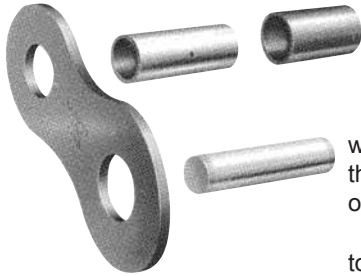

Fig. 3 Morse Roller Chain





At Emerson, we're not satisfied with just being "good enough;" we've earned our reputation as the smart choice in chain through constant attention to detail, and we're not about to let up. When all is said and done, it's obvious that one of the keys to building a better chain is to build superior chain components.

We've all heard the old saying—"A chain is only as strong as its weakest link." Substitute the word "pin," "bushing," or "roller" for "link," and it would still be just as true. It really is the little things that can make or break any chain application. No matter how expert the assembly, just one inferior chain component could cost you thousands of dollars in maintenance and downtime.

That's why Emerson takes extra care of each and every chain component to insure your total satisfaction. We pay attention to even the smallest consideration because we know you can't afford premature chain failure.

Links

Morse® pin and roller links feature an optimal shape for both weight and strength considerations.

Link apertures go through a series of important processes, including precision piercing, shaving and ballizing. This extra effort pays dividends in the form of a straight, smooth, fatigue-resistant surface finish which improves pin contact and retention. Adding to Morse's superior strength and wear life is the carefully controlled selection of materials and heat treatment.

Like most engineering societies worldwide, Morse has recognized shot peening as an effective means of extending life in machine components. Studies show this technique to greatly improve crack resistance by compressing the link's surface.

Pins

Morse® end pins provide easy entry for precision assembly. Precision grinding and controlled case hardening add to Morse's extended wear life.

Bushings

Surface finish on the Morse® bushings makes the competition look downright dirty. The smooth, clean finish helps keep us in service long after the others have faded away.

A stronger core and hardened surface make the Morse bushing a tough case to crack, even under adverse operating conditions.

The round shape, both inside and outside, improves the surface contact with both the pin and roller. This results in less wear and longer life.

Rollers

Loads that destroy many competitive rollers are confidently handled by durable Morse® rollers. We have designed the optimal wall thickness to reduce roller weight; shot peening is applied to improve finish and impact strength. Morse's processes further enhance impact fatigue resistance.

Now, you've seen what kind of effect component quality can have on your application, but there's more to making great chain than just having the right parts.

We could make our chain out of 14-karat gold, but it wouldn't mean a thing if the assembly technology wasn't up to those same solid gold standards. It's the combination of precision parts and design expertise that puts Morse in a class by itself.

To many other chain suppliers, assembly is just a final detail before shipping. To Morse, there's nothing more important than seeing that your chain comes together in such a way that it stays together

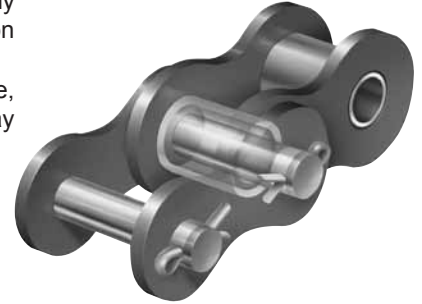

Controlled pitch

Morse® chain strikes a unique pitch balance between the roller link and pin link assemblies. Our studies have shown that only the pin link section experiences elongation due to wear, so this section is designed to be initially shorter. By making a special allowance for this elongation or "stretch," the Morse chain drive wears longer and smoother than competitive models. Pitch control also helps insure optimal alignment with sprockets.

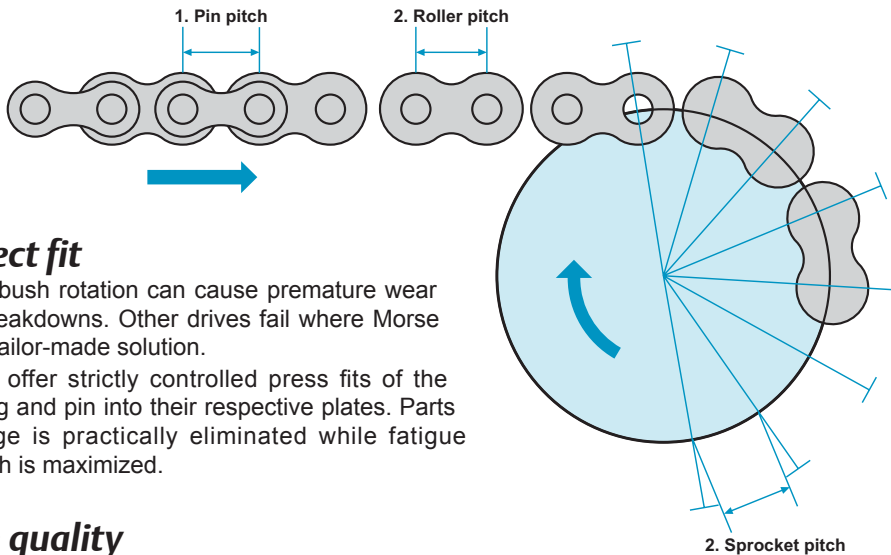

1. Morse chain compensates for wear elongation in pin link section.
2. Roller and sprocket pitch remain relatively constant.

Perfect fit

Pin or bush rotation can cause premature wear and breakdowns. Other drives fail where Morse has a tailor-made solution.

We offer strictly controlled press fits of the bushing and pin into their respective plates. Parts slippage is practically eliminated while fatigue strength is maximized.

High quality

The high quality and superior performance of Morse chain permits the designer to optimize the selection of a drive. Consult Technical Service to review the application and assist in selecting the optional chain drive.

Automotive
Bakery Machinery
Brick & Clay Equipment
Conveying
Cotton Picker
Cranes & Hoists
Fans
Fire Truck Pumps
Grain Mill Machinery
Logging
Machine Tools
Marine Drives
Motorcycle
Printing Machinery Pumps
Sticker Stokers
Tomato Carrier
Tractor
Wrench

You've got two very different chain applications. You go to two different chain suppliers, right? Wrong! You only need one if you choose Morse.

Higher standards

When other companies say "standard," they usually mean a small handful of prepackaged, high volume chain sizes and that's it. Morse®, however, sets a new standard for different types and sizes of chain.

For instance, Morse® provides LEAF chain, a necessity for certain material handling applications. And our extensive attachment chain line provides a variety of simple solutions to difficult conveying problems.

For corrosive environments, choose from non-metallic, sintered bush, nickel-plated and stainless steel chains. They're all built strong to last longer than competitive chains.

Custom is customary

Unlike other chain suppliers, we aren't afraid to take on the tough jobs, the ones that don't fit into any simple category. Our engineering know how and versatility allow us to provide custom chain for virtually any situation. Like the huge HV chains that drive a stern wheel showboat. Or the precision roller chain timing chains in your car or truck.

They're all as unique as you are, and they're all provided by Morse.

Inverted tooth offers more bite than ever "Section I"

For transmitting high horsepower in a small space, consider our many HV inverted tooth chain options. Now, with greater HP ratings than ever before, you can't afford not to look at Morse HV chain for your special use.

Engineered specifically for each individual application, the Morse HV drives are popular for recreational vehicles, airport servicing equipment, motorcycles and a variety of stationary industrial installations.

As the pioneer in this field, Morse has become so experienced at designing these custom HV drives that delivery time is usually the same as that of an off-the-shelf product. In fact, HV chain and sprockets are available from stock.





From pipe spinners to flood control pumps to gas turbine starter drives, applications in need of high speed performance with a greater load capacity count on Morse HV chain for smooth, quiet, cost-efficient operation.

Morse® silent chain is another inverted tooth type drive available in several standard sizes. It will transmit power as smoothly as a belt at speeds up to 10,000 rpm. 3/16" pitch silent chain

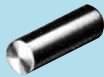

has successfully powered photocopying equipment, packaging machinery and missile launchers.

With so many choices, how do you decide what's right for you? Let us provide our expert application assistance. Like our product offering, engineering service sets us apart from the competition.

	Feature	Contributes to:
<p>Links</p> 	<p>Link contour size & shape optimization Apertures Shaved</p> <p>Carbon restoration heat treat cycle Shot peening Apertures ballized</p>	<p>Tensile & fatigue strength Finish & Bearing .. Fatigue strength</p> <p>Uniform hardness .. Higher fatigue strength Fatigue strength Improved fatigue strength thru imparted residual stresses.</p>
<p>Pins</p> 	<p>Alloy steels Controlled case hardening</p> <p>Precision grinding</p>	<p>Optimum wear, strength, & fatigue strength Optimum balance between a hard, long wearing surface and a tough, high strength core Optimum wear, strength, & fatigue strength</p>
<p>Bushings</p> 	<p>Heavy wall "Extrude" processing</p> <p>Controlled case hardening</p>	<p>Greater strength, impact resistance Uniform wall for consistent pitch Round bore for superior bearing surface Optimum link-bushing fit for improved retention and fatigue life.</p> <p>Optimum case depth and hardness control for long wear life plus tough, impact resistant core.</p>
<p>Rollers</p> 	<p>Extruded rollers — 1 1/4 " pitch type drive thru 2" pitch Customized heat treat cycles Shot peening</p>	<p>Highest impact fatigue resistance</p> <p>Extended wear life & higher fatigue life Improved impact fatigue resistance</p>
<p>Assembly</p> 	<p>Machine inspection Automatic assembly In-line pre-stress</p>	<p>Qualified components & sub-assemblies Consistently uniform assembly Every component in every pitch carries its proportionate share of load Improved endurance strength thru imparted residual stresses</p>
<p>Petrolatum Dipping</p> 	<p>Hot-dip—low viscosity soak</p>	<p>Full penetration with maximum excess carry-off Good corrosion protection for maximum shelf life Assures joint lubrication for initial start-up</p>
<p>Material procurement and control</p>	<p>Constant surveillance of the suppliers' facilities, as well as continuing material inspections in process at Emerson, helps assure that the customer will receive a chain that is manufactured from the highest quality materials available.</p>	



Chain Assembly

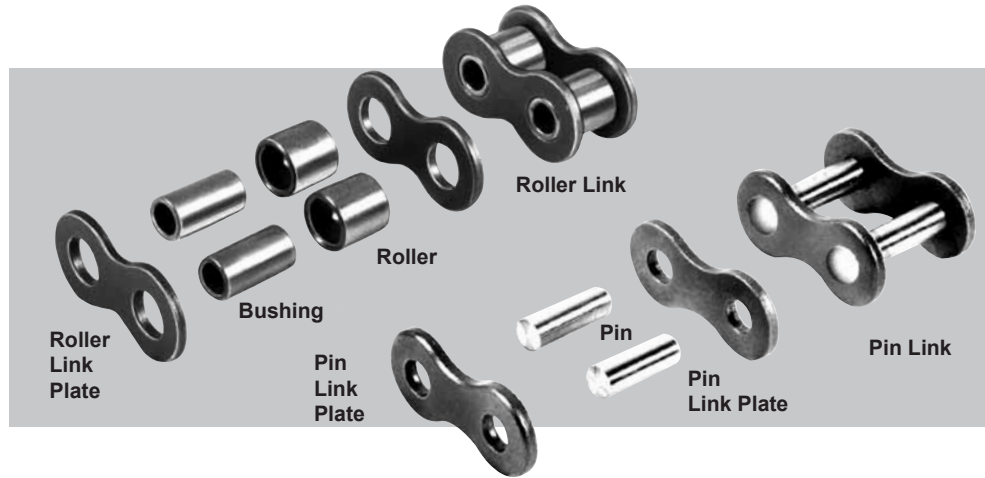

Connecting links

Standard ("C") has a removable plate with a slip fit ("SF") on the pins which allows easy assembly and disassembly. Depending on pitch this may be furnished with Spring Clip or Cotter Keys. **Optional ("CON")** has a removable plate with a light press fit ("PF") on the pins. This is superior in service and used on heavy applications. This is furnished with Cotter Keys.

Regular offset links

Regular Offset Links are used (one per chain) when a chain length contains an odd number of pitches. Regular Offset Links are standard for all pitches in both single-width and multiple width roller chains. The pin has a slip fit in both plates and is flat on one end to prevent rotation.

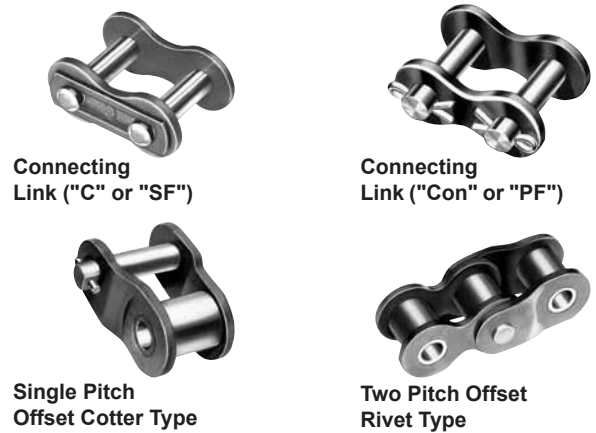

Power transmission and conveyor series

Pitch	Power Trans. Series (1)	Conveyor Series		Connecting Link Types			Connecting Links Furnished With Stock Lgth Chain	Offset Link
				"SF" Link (Slip Fit)		"PF" Link (Light Press Fit)		
				Spring Clip	Cotter	Cotter		
1/4, 3/8, 1/2 & 5/8"	25,35,40,41,50	-	-	Standard	None	None	1 each 10'	Cotter
3/4"	60	-	-	Optional	Standard	Optional	1 each 10'	
1"	80	-	-	Optional	Standard	Optional	1 each 10'	
1 1/4, 1 1/2, 1 3/4"	100,120,140	-	-	None	Standard	Optional	1 each 10'	
2, 2 1/2"	160,200	-	-	None	Standard	Optional	1 each 10'	
1 & 1 1/4"	2040,2050	C-2040, C-2050	C-2042, C-2052	Standard	None	None	1 each 10'	
1 1/2"	2060	C-2060H	C-2062, C-2062HT	Optional	Standard	Optional	1 each 10'	
2"	2080	C-2080H	C-2082H	None	Standard	Optional	1 each 10'	
2 1/2" & 3"	None	C-2100H, C-2120H	C-2102H, C-2122H	None	Standard	Optional	1 each 10'	

(1) Includes Standard, "M", Sintered Bush, and Double Pitch
 Note: Use of Slip Fit and offset connecting links should be avoided in highly loaded drives.
 Heavy, "8" Heavy, 60 and above are light press fit connectors.

Nickel plate and stainless steel

Pitch	Chain Number	Connecting Link Types			Connecting Links Furnished With Stock Lgth Chain	Offset Link
		"SF" Link (Slip Fit)		"PF" Link (Light Press Fit)		
		Spring Clip	Cotter	Cotter		
3/8", 1/2" & 5/8"	35N, 40N, 50N	Standard	None	None	1 each 10'	Cotter
3/4"	60N	None	Standard	None	1 each 10'	Cotter
3/8"	35SS	Standard	None	None	1 each 10'	2 Pitch Rivet
1/2", 5/8" & 3/4"	40SS, 50SS, 60SS	None	Standard	None	1 each 10'	2 Pitch Rivet

Packaged chain

Morse pioneered "off-the-shelf" merchandising of packaged chain-Morse brings you in addition to Roller Chain packaging -Silent Chain, HV Chain, and the packaging of roller chain

parts in individual "**POLY-PACK**" polyethylene marked packages. Stock picking and inventory taking problems are greatly reduced with the Morse easy to read packages and cartons.

Roller chain

ANSI No.	Pitch	Single Strand						Double Strand		Triple Strand		Quad Strand	
		Box	Wt. (Lbs.)	Reel	Wt. (Lbs.)	Reel	Wt. (Lbs.)	Length	Wt. (Lbs.)	Length	Wt. (Lbs.)	Length	Wt. (Lbs.)
25	1/4"	10'	2.0										
35	3/8"	10'	2.5	50'	12.9	100'	24	10'	4.7	10'	6.6	10'	8.9
41	1/2"	10'	3.1	50'	15.5	100'	30						
40	1/2"	10'	4.4	50'	22.8	100'	45	10'	8.8	10'	12.4	10'	17.1
50	5/8"	10'	7.1	50'	37.8	100'	72	10'	13.9	10'	20.5	10'	29.0
60	3/4"	10'	10.5	50'	66.0	100'	106	10'	20.5	10'	29.0	10'	39.0
80	1"	10'	17.6	50'	90.0	*100'	167	10'	34.9	10'	50.5	10'	65.0
100	1 1/4"	10'	27.0	*50'				10'	54.0	10'	80.0	10'	108.0
120	1 1/2"	10'	39.0	*50'	—	—	—	10'	82.0	10'	121.0	10'	160.0
140	1 3/4"	10'	49.0					10'	108.0	10'	155.0	10'	214.0
160	2"	10'	64.0					10'	133.0	10'	199.0	10'	265.0
200	2 1/2"	10'	107.0					10'	215.0	10'	315.0	10'	420.0

Stainless Steel Chain 35-SS thru 60-SS } Packaged same as above (single strand only).
 Sintered Bushed Chain 40-SB thru 80-SB }
 Heavy Series Roller Chain-Single, double, triple, and quad strand packaged in 10' lengths.
 *Rivet Construction

Double pitch chain

Chain No.	Box	Reel	Wt. (Lbs.)		Chain No.	Box	Reel	Wt. (Lbs.)		Chain No.	Box	Wt. (Lbs.)
			Box	Reel				Box	Reel			
2040	10'	100'	3.0	30.0	2060	10'	100'	7.0	70.0	C-2100H	10'	24.7
C-2040			3.4	34.0	C-2060H			10.1	101.0	C-2102H		39.6
C-2042	10'	-	5.8	-	C-2062H	10'	-	14.8	-			
2050	10'	100'	5.0	50.0	2080	10'	-	12.2	-	C-2120H	10'	35.6
C-2050			5.6	56.0	C-2080H			16.7	-	C-2122H		55.6
C-2052	10'	-	8.8	-	C-2082H			24.0	-			

Silent chain

Pitch	Chain No.	Box	Weight In Pounds	
3/8"	SC-302	10'	3.8	
	SC-303	10'	5.6	
	SC-304	10'	7.5	
	SC-305	10'	9.4	
	SC-306	10'	12.5	
	SC-308	10'	15.0	
1/2"	SC-403	10'	7.5	
	SC-404	10'	10.0	
	SC-405	10'	12.5	
	SC-406	10'	15.0	
	SC-408	10'	20.0	
	SC-410	10'	25.0	
	SC-412	10'	30.0	
	SC-414	10'	35.0	
	3/4"	SC-606	10'	25.0
		SC-608	10'	30.0
SC-610		10'	37.5	
SC-612		10'	45.0	
SC-616		10'	60.0	
SC-620		10'	75.0	
1"	SC-812	10'	60.5	
	SC-816	10'	82.0	
	SC-820	10'	102.0	
	SC-824	10'	122.0	

Stock Chain is supplied with one-connecting link set. Additional connecting link sets sold only in package ("**POLY-PACK**") quantities.
 Package quantities: (25) for 3/8" and 1/2" pitch; (10) for 3/4" pitch; (5) for 1" pitch. Offsets are in "**POLY-PACK**" with one offset link per pack.
 NOTE: HV chain package lengths - Section I.

Roller chain parts

ANSI No.	Pitch	Part-Name (Link)	Single Strand *Qty. per box	Wt. (Lb.) per pkg	Double Strand *Qty. per box	Wt. (Lb.) per pkg.	Triple Strand *Qty. per box	Wt. (Lb.) per pkg.	Quad. Strand *Qty. per box	Wt. (Lb.) per pkg.
25	1/4"	Conn.	10	0.05						
		Bush.	10	0.05						
		Offset	10	0.10						
35†	3/8"	Conn.	25	0.4	10	0.3	5	0.2	5	1.0
		Bush.	25	0.4						
		Offset	25	0.4	10	0.3	5	0.2	5	.03
41†	1/2"	Conn.	25	0.5						
		Roller	25	0.5						
		Offset	25	0.5						
40†	1/2"	Conn.	25	0.6	10	0.5	5	0.6	5	.06
		Roller	25	0.8						
		Offset	25	0.8	10	0.5	5	0.6	5	.07
50†	5/8"	Conn.	25	1.0	10	0.6	5	0.5	5	.12
		Roller	25	1.3						
		Offset	25	1.3	10	1.0	5	0.6	5	.15
60†	3/4"	Conn.	25	1.6	10	1.6	5	0.8	5	.21
		Roller	25	2.0						
		Offset	25	2.0	10	1.6	5	1.0	5	.27
80	1"	Conn.	20	2.8	5	1.5	2	0.7	2	.49
		Roller	20	3.5						
		Offset	20	3.5	5	1.5	2	1.0	2	.63

ANSI No.	Pitch	Part-Name (Link)	Single Strand *Qty. per box	Wt. (Lb.) per pkg.	Double Strand *Qty. per box	Wt. (Lb.) per pkg.	Triple Strand *Qty. per box	Wt. (Lb.) per pkg.	Quad. Strand *Qty. per box	Wt. (Lb.) per pkg.
100	1 1/4"	Conn.	5	1.5	2	1.0	2	1.5	2	.90
		Roller	5	1.8						
		Offset	5	1.8	2	1.2	2	1.9	2	1.17
120	1 1/2"	Conn.	5	2.3	2	1.6	2	2.5	2	1.58
		Roller	5	3.0						
		Offset	5	2.9	2	2.0	2	3.2	2	2.06
140	1 3/4"	Conn.	2	1.5	2	2.4	1	1.8	1	2.38
		Roller	2	1.8						
		Offset	2	1.8	2	3.2	1	2.3	1	3.10
160	2"	Conn.	2	2.1	2	3.8	1	2.7	1	3.59
		Roller	2	2.7						
		Offset	2	2.7	2	4.8	1	3.2	1	4.35
200	2 1/2"	Conn.	1	2.1	1	3.8	1	5.7	1	7.51
		Roller	1	2.8						
		Offset	1	2.7	1	4.9	1	7.1	1	9.41

* Multiple strand chains use single strand roller links; all parts are "POLY-PACK"
 † Spring clips are available for # 35 through #60 at 50 per pack.

Sintered Bushed Chain 40-SB thru 60-SB Packaged same as above
 Nickel Plated Chain 35N thru 60N Packaged same as above
 STANDARD CARBON STEEL STOCK ATTACHMENTS - 1 pc/package

Heavy series parts

ANSI No.	Pitch	Part-Name (Link)	Single Strand *Qty. per box	Wt. (Lb.) per pkg.	Double Strand *Qty. per box	Wt. (Lb.) per pkg.	Triple Strand *Qty. per box	Wt. (Lb.) per pkg.	Quad Strand *Qty. per box	Wt. (Lb.) per pkg.
60H	3/4"	Conn.	5	0.35	5	0.13	5	0.20	5	0.26
		Roller	5	0.50						
		Offset	5	0.43	5	0.16	5	0.24	5	0.33
80H	1"	Conn.	5	0.76	5	0.30	5	0.44	5	0.58
		Roller	5	0.90						
		Offset	5	0.84	5	0.37	5	0.55	5	0.73
100H	1 1/4"	Conn.	2	0.56	2	0.53	2	0.79	2	1.05
		Roller	2	0.67						
		Offset	2	0.80	2	0.68	2	1.01	2	1.34
120H	1 1/2"	Conn.	2	1.00	2	0.91	2	1.35	2	1.78
		Roller	2	1.20						
		Offset	2	1.20	2	1.17	2	1.74	2	2.32
140H	1 3/4"	Conn.	2	1.90	2	1.35	2	2.00	2	2.65
		Roller	2	1.90						
		Offset	2	2.00	2	1.78	2	2.65	2	3.52
160H	2"	Conn.	2	2.02	2	1.98	2	2.94	2	3.90
		Roller	2	2.67						
		Offset	2	2.63	2	2.59	2	3.86	2	5.13
200H	2 1/2"	Conn.	1	2.28	1	3.57	1	5.69	1	8.65
		Roller	1	3.00						
		Offset	1	2.87	1	5.63	1	8.39	1	11.15

* Multiple strand chains use single strand roller links; all parts are "POLY-PACK"

Stainless steel parts

ANSI No.	Pitch	Part Name (Link)	Single Strand "Qty" per box	Wt. (Lb.) per pkg	ANSI No.	Pitch	Part Name (Link)	Single Strand "Qty" per box	Wt. (Lb.) per pkg.
25SS	1/4"	Conn.	25	.13	41SS	1/2"	Conn.	25	.29
		Roller	25	.13			Roller	25	.50
		Offset	10	.10			Offset	10	.50
35SS	3/8"	Conn.	25	.20	50SS	5/8"	Conn.	25	1.00
		Roller	25	.40			Roller	25	1.30
		Offset	10	.80			Offset	10	.90
40SS	1/2"	Conn.	25	.60	60SS	3/4"	Conn.	25	1.60
		Roller	25	.60			Roller	25	2.00
		Offset	10	.60			Offset	10	1.60
80SS	1"	Conn.	25	3.25	80SS	1"	Roller	25	4.10
		Roller	25	4.10			Roller	25	4.10
		Offset	10	3.25			Offset	10	3.25

All parts are "POLY-PACK"

Double pitch parts

ANSI	Pitch	Part-Name (Link)	Qty. per box	Wt. (Lb.) per pkg.	
2040	1"	Conn.	5	.2	
		Roller	5	.2	
		Offset	5	.2	
C-2042†	1"	Conn.	1	.1	
		Roller	1	.1	
		Offset	1	.1	
2050	1 1/4"	Conn.	5	.4	
		Roller	5	.4	
		Offset	5	.4	
C-2052†	1 1/4"	Conn.	5	.4	
		Roller	1	.1	
		Offset	1	.1	
2060	1 1/2"	Conn.	5	.5	
		Roller	5	.5	
		Offset	5	.5	
	C-2060H	1 1/2"	Conn.	5	.6
			Roller	5	.7
			Offset	5	.7
C-2062H†	1 1/2"	Conn.	5	.6	
		Roller	5	.7	
		Offset	5	.7	
2080	2"	Conn.	1	.3	
		Roller	1	.2	
		Offset	1	.2	
C-2080H	2"	Conn.	5	1.5	
		Roller	5	1.2	
		Offset	5	1.1	
	C-2082H†	2"	Conn.	5	1.5
			Roller	5	1.5
			Offset	5	1.5
C-2100H	2 1/2"	Conn.	2	1.1	
		Roller	2	1.1	
		Offset	2	1.1	
C-2102H†	2 1/2"	Conn.	2	1.1	
		Roller	1	1.2	
		Offset	1	.8	
C-2120H	3"	Conn.	1	0.9	
		Roller	1	0.9	
		Offset	1	0.9	
C-2122H†	3"	Conn.	1	0.9	
		Roller	1	2.1	
		Offset	1	1.4	

† Large roller conveyor series chain uses same Connecting Link as Conveyor series chain; all parts are "POLY-PACK"

Standard series-single strand

Catalog No.	Dimensions (Inches)									Average Tensile Strength	Weight Per Foot
	Pitch	W-Roller Width	D-Roller Dia.	C-Pin Dia.	F-Plate Thickness	L-Width Over Pins	H-Inside Plate Height	†N	†M		
*25	1/4	1/8	.130	.0905	.030	.312	.234	.156	.188	875	.09
*35	3/8	3/16	.200	.141	.050	.466	.350	.233	.267	2,100	.21
41	1/2	1/4	.306	.141	.050	.512	.383	.256	.322	2,000	.25
40	1/2	5/16	.312	.156	.060	.630	.466	.315	.380	3,700	.42
50	5/8	3/8	.400	.200	.080	.790	.584	.395	.460	6,100	.69
60	3/4	1/2	.468	.234	.094	.990	.700	.495	.586	8,500	1.00
80	1	5/8	.625	.312	.125	1.274	.934	.637	.741	14,500	1.71
100	1 1/4	3/4	.750	.375	.156	1.555	1.166	.778	.923	24,000	2.58
120	1 1/2	1	.875	.437	.187	1.960	1.400	.980	1.150	34,000	3.87
140	1 3/4	1	1.000	.500	.219	2.117	1.634	1.059	1.215	46,000	4.95
160	2	1 1/4	1.125	.562	.250	2.522	1.866	1.261	1.451	58,000	6.61
200	2 1/2	1 1/2	1.562	.781	.312	3.120	2.250	1.560	1.777	95,000	10.96

Heavy series-single strand

60-H	3/4	1/2	.468	.234	.125	1.115	.700	.558	.627	8,500	1.22
80-H	1	5/8	.625	.312	.156	1.400	.934	.700	.804	14,500	2.03
100-H	1 1/4	3/4	.750	.375	.187	1.684	1.166	.842	.986	24,000	3.00
120-H	1 1/2	1	.875	.437	.219	2.090	1.400	1.045	1.214	34,000	4.30
140-H	1 3/4	1	1.000	.500	.250	2.241	1.634	1.121	1.276	46,000	5.50
160-H	2	1 1/4	1.125	.562	.281	2.646	1.866	1.323	1.513	58,000	7.20
200-H	2 1/2	1 1/2	1.562	.781	.375	3.374	2.334	1.687	1.904	95,000	12.30

* Rollerless

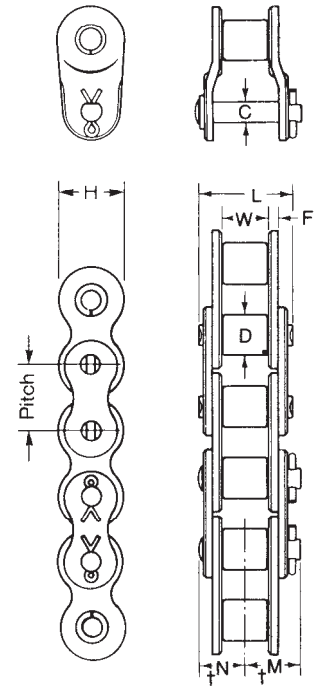

Standard series-double strand

Catalog No.	Dimensions (Inches)									Average Tensile Strength	Weight Per Foot
	Pitch	W-Roller Width	D-Roller Dia.	C-Pin Dia.	F-Plate Thickness	L-Width Over Pins	H-Inside Plate Height	†N	†M		
*35-2	3/8	3/16	.200	.141	.050	.866	.350	.433	.467	4,200	.40
40-2	1/2	5/16	.312	.156	.060	1.215	.466	.597	.662	7,400	.82
50-2	5/8	3/8	.400	.200	.080	1.507	.584	.753	.832	12,200	1.36
60-2	3/4	1/2	.468	.234	.094	1.893	.700	.947	1.038	17,000	1.99
80-2	1	5/8	.625	.312	.125	2.432	.934	1.216	1.320	29,000	3.40
100-2	1 1/4	3/4	.750	.375	.156	2.963	1.166	1.482	1.625	48,000	5.10
120-2	1 1/2	1	.875	.437	.187	3.749	1.400	1.874	2.047	68,000	7.65
140-2	1 3/4	1	1.000	.500	.219	4.041	1.634	2.020	2.187	92,000	9.80
160-2	2	1 1/4	1.125	.562	.250	4.827	1.866	2.414	2.625	116,000	13.10
200-2	2 1/2	1 1/2	1.562	.781	.312	5.937	2.250	2.968	3.281	190,000	21.50

Heavy series-double strand

60-2H	3/4	1/2	.468	.234	.125	2.148	.700	1.074	1.166	17,000	2.41
80-2H	1	5/8	.625	.312	.156	2.688	.934	1.344	1.448	29,000	4.00
100-2H	1 1/4	3/4	.750	.375	.187	3.228	1.166	1.614	1.758	48,000	5.70
120-2H	1 1/2	1	.875	.437	.220	4.019	1.400	2.009	2.179	68,000	8.40
140-2H	1 3/4	1	1.000	.500	.250	4.301	1.634	2.150	2.307	92,000	10.80
160-2H	2	1 1/4	1.125	.562	.281	5.087	1.866	2.593	2.684	116,000	14.20
200-2H	2 1/2	1 1/2	1.562	.781	.375	6.462	2.334	3.231	3.448	190,000	24.30

* Rollerless

All sizes available in Riveted construction. Sizes 60 and above available in Cottered construction. Please specify desired construction when ordering.

Standard multiple-strand chains are supplied with loose-fit center plates. Morse press-lit center plates are available on special order. Chains on this page should not be used for Hoisting applications. Consult Morse for Hoist application recommendations.

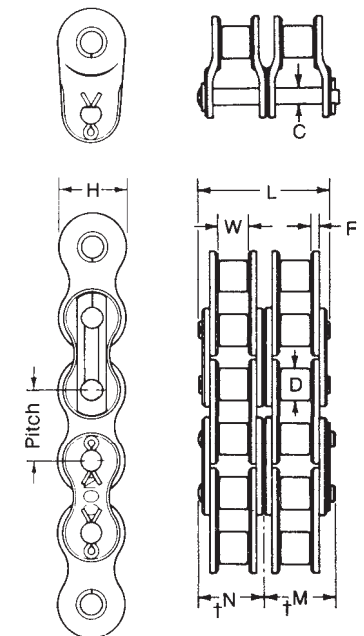

† For cotter chain and connector link clearance.

Standard series-triple strand

Catalog No.	Dimensions (Inches)									Average Tensile Strength	Weight Per Foot
	Pitch	W-Roller Width	D-Roller Dia.	C-Pin Dia.	F-Plate Thickness	L-Width Over Pins	H-Inside Plate Height	+N	+M		
35-3*	3/8	3/16	.200	.141	.050	1.265	.350	.632	.703	6,300	.66
40-3	1/2	5/16	.312	.156	.060	1.780	.466	.880	.968	11,100	1.23
50-3	5/8	3/8	.400	.200	.080	2.220	.584	1.110	1.203	18,300	2.02
60-3	3/4	1/2	.468	.234	.094	2.790	.700	1.395	1.500	25,500	2.96
80-3	1	5/8	.625	.312	.125	3.585	.934	1.792	1.905	43,500	5.09
100-3	1 1/4	3/4	.750	.375	.156	4.371	1.166	2.186	2.329	72,000	7.61
120-3	1 1/2	1	.875	.437	.187	5.538	1.400	2.769	2.938	102,000	11.43
140-3	1 3/4	1	1.000	.500	.219	5.965	1.634	2.982	3.156	138,000	14.63
160-3	2	1 1/4	1.125	.562	.250	7.132	1.866	3.566	3.782	174,000	19.58
200-3	2 1/2	1 1/2	1.562	.781	.312	8.754	2.250	4.377	4.704	285,000	32.04

Heavy series-triple strand

60-3H	3/4	1/2	.468	.234	.125	3.176	.700	1.588	1.680	25,500	3.60
80-3H	1	5/8	.625	.312	.156	3.971	.934	1.985	2.090	43,500	6.00
100-3H	1 1/4	3/4	.750	.375	.187	4.767	1.166	2.383	2.528	72,000	8.60
120-3H	1 1/2	1	.875	.437	.219	5.943	1.400	2.971	3.141	102,000	12.60
140-3H	1 3/4	1	1.000	.500	.250	6.356	1.634	3.178	3.334	138,000	16.10
160-3H	2	1 1/4	1.125	.562	.281	7.253	1.866	3.761	3.952	174,000	21.20
200-3H	2 1/2	1 1/2	1.562	.781	.375	9.545	2.334	4.772	4.990	285,000	36.20

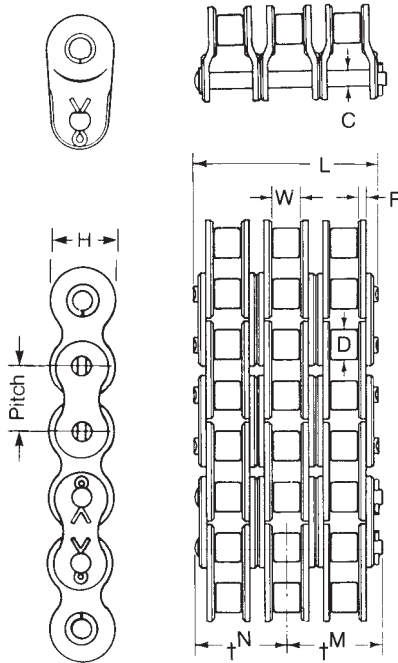

Standard series-quadruple strand

Catalog No.	Dimensions (Inches)									Average Tensile Strength	Weight Per Foot
	Pitch	W-Roller Width	D-Roller Dia.	C-Pin Dia.	F-Plate Thickness	L-Width Over Pins	H-Inside Plate Height	+N	+M		
*35-4	3/8	3/16	.200	.141	.050	1.664	.350	.832	.906	8,400	.88
40-4	1/2	5/16	.312	.156	.060	2.345	.466	1.162	1.250	14,800	1.64
50-4	5/8	3/8	.400	.200	.080	2.933	.584	1.466	1.547	24,400	2.76
60-4	3/4	1/2	.468	.234	.094	3.688	.700	1.844	1.938	34,000	3.94
80-4	1	5/8	.625	.312	.125	4.738	.934	2.369	2.469	58,000	6.77
100-4	1 1/4	3/4	.750	.375	.156	5.779	1.166	2.889	3.031	96,000	10.12
120-4	1 1/2	1	.875	.437	.187	7.327	1.400	3.663	3.828	136,000	15.20
140-4	1 3/4	1	1.000	.500	.219	7.889	1.634	3.945	4.125	184,000	19.48
160-4	2	1 1/4	1.125	.562	.250	9.437	1.866	4.718	4.938	232,000	26.07
200-4	2 1/2	1 1/2	1.562	.781	.312	11.571	2.334	5.785	6.109	380,000	42.59

Heavy series-quadruple strand

60-4H	3/4	1/2	.468	.234	.125	4.204	.700	2.102	2.194	34,000	4.80
80-4H	1	5/8	.625	.312	.156	5.524	.934	2.627	2.731	58,000	7.90
100-4H	1 1/4	3/4	.750	.375	.187	6.306	1.166	3.153	3.297	96,000	11.50
120-4H	1 1/2	1	.875	.437	.219	7.867	1.400	3.933	4.103	136,000	16.80
140-4H	1 3/4	1	1.000	.500	.250	8.411	1.634	4.205	4.362	184,000	21.50
160-4H	2	1 1/4	1.125	.562	.281	9.959	1.866	4.979	5.170	232,000	28.30
200-4H	2 1/2	1 1/2	1.562	.781	.375	12.628	2.334	6.314	6.531	380,000	48.20

* Rollerless

All sizes available in Riveted construction. Sizes 60 and above available in Cottered construction. Please specify desired construction when ordering.

Standard multiple-strand chains are supplied with loose-fit center plates. Morse press-fit center plates are available on special order.

Chains on this page should not be used for Hoisting applications. Consult Morse for Hoist application recommendations.

† For cotter chain and connector link clearance.

Standard series-quintuple strand

Catalog No.	Dimensions (Inches)									Average Tensile Strength	Weight Per Foot
	Pitch	W-Roller Width	D-Roller Dia.	C-Pin Dia.	F-Plate Thickness	L-Width Over Pins	H-Inside Plate Height	†N	†M		
60-5	3/4	1/2	.468	.234	.094	4.584	.700	2.292	2.384	42,500	4.92
80-5	1	5/8	.625	.312	.125	5.891	.934	2.945	3.050	72,500	8.46
100-5	1 1/4	3/4	.750	.375	.156	7.187	1.166	3.593	3.739	120,000	12.63
120-5	1 1/2	1	.875	.437	.187	9.116	1.400	4.558	4.728	170,000	18.98
140-5	1 3/4	1	1.000	.500	.219	9.813	1.634	4.906	5.063	230,000	24.33
160-5	2	1 1/4	1.125	.562	.250	11.742	1.866	5.871	6.061	290,000	35.56

heavy series-quintuple strand

60-5H	3/4	1/2	.469	.234	.125	5.232	.700	2.616	2.708	42,500	5.99
80-5H	1	5/8	.625	.312	.156	6.537	.934	3.268	3.373	72,500	9.87
100-5H	1 1/4	3/4	.750	.375	.187	7.845	1.166	3.922	4.067	120,000	14.40
120-5H	1 1/2	1	.875	.437	.219	9.791	1.400	4.895	5.065	170,000	21.00
140-5H	1 3/4	1	1.000	.500	.250	10.466	1.634	5.233	5.389	230,000	26.80
160-5H	2	1 1/4	1.125	.562	.281	12.395	1.866	6.197	6.388	290,000	35.30

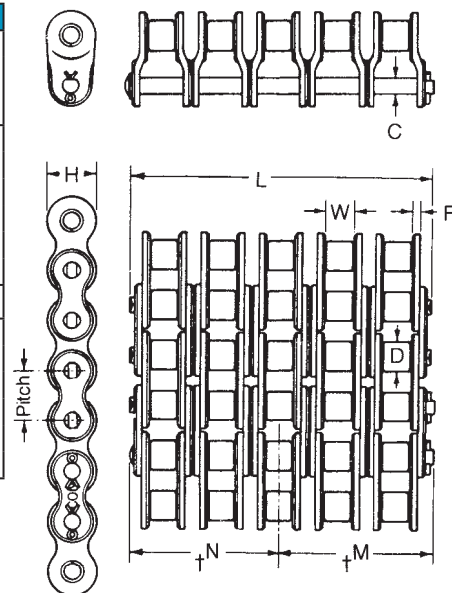

Standard series-sextuple strand

Catalog No.	Dimensions (Inches)									Average Tensile Strength	Weight Per Foot
	Pitch	W-Roller Width	D-Roller Dia.	C-Pin Dia.	F-Plate Thickness	L-Width Over Pins	H-Inside Plate Height	†N	†M		
60-6	3/4	1/2	.468	.234	.094	5.481	.700	2.740	2.833	51,000	5.90
80-6	1	5/8	.625	.312	.125	7.044	.934	3.522	3.626	87,000	10.15
100-6	1 1/4	3/4	.750	.375	.156	8.595	1.166	4.297	4.443	144,000	15.14
120-6	1 1/2	1	.875	.437	.187	10.905	1.400	5.452	5.623	204,000	22.76
140-6	1 3/4	1	1.000	.500	.219	11.737	1.634	5.868	6.025	276,000	29.18
160-6	2	1 1/4	1.125	.562	.250	14.047	1.866	7.023	7.214	348,000	39.05

Heavy series-sextuple strand

60-6H	3/4	1/2	.469	.234	.125	6.260	.700	3.130	3.222	51,000	7.18
80-6H	1	5/8	.625	.312	.156	7.820	.934	3.910	4.014	87,000	11.84
100-6H	1 1/4	3/4	.750	.375	.187	9.384	1.166	4.692	4.836	144,000	17.30
120-6H	1 1/2	1	.875	.437	.219	11.715	1.400	5.857	6.027	204,000	25.20
140-6H	1 3/4	1	1.000	.500	.250	12.521	1.634	6.260	6.417	276,000	32.10
160-6H	2	1 1/4	1.125	.562	.281	14.831	1.866	7.415	7.606	348,000	42.30

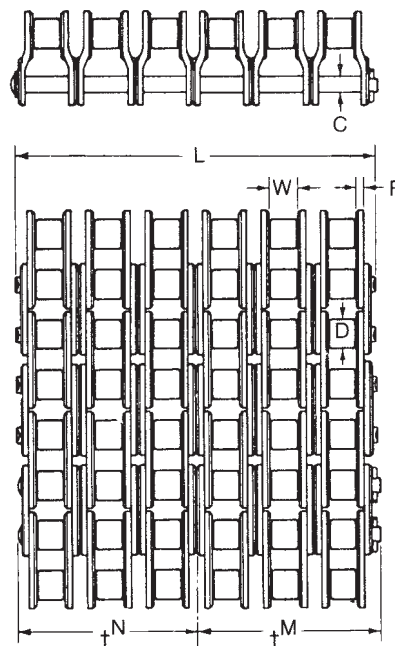

Available in Riveted and Cottered construction. Please specify desired construction when ordering.
Standard multiple-strand chains are supplied with loose-fit center plates. Morse press-fit center plates are available on special order.
Chains on this page should not be used for Hoisting applications. Consult Morse for Hoist application recommendations.

† For cotter chain and connector link clearance.

Standard series-octuple strand

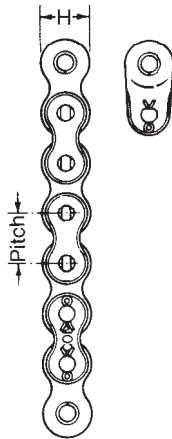

Catalog No.	Dimensions (Inches)									Average Tensile Strength	Weight Per Foot
	Pitch	W-Roller Width	D-Roller Dia.	C-Pin Dia.	F-Plate Thickness	L-Width Over Pins	H-Inside Plate Height	tN	tM		
60-8	3/4	1/2	.468	.234	.094	7.275	.700	3.637	3.730	68,000	7.86
80-8	1	5/8	.625	.312	.125	9.350	.934	4.675	4.779	116,000	13.53
100-8	1 1/4	3/4	.750	.375	.156	11.411	1.166	5.705	5.851	192,000	20.16
120-8	1 1/2	1	.875	.437	.187	14.483	1.400	7.242	7.411	272,000	30.32
140-8	1 3/4	1	1.000	.500	.219	15.585	1.634	7.792	7.949	368,000	38.88
160-8	2	1 1/4	1.125	.562	.250	18.657	1.866	9.328	9.515	464,000	52.03

Standard multiple-strand chains are supplied with loose-fit center plates. Morse press-fit center plates are available on special order. Available in Riveted construction. Please specify desired construction when ordering. Chains on this page should not be used for Hoisting applications. Consult Morse for Hoist application recommendations.

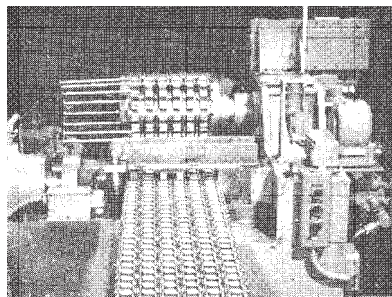

Multiple strand with press-fit center plates

Multiple-strand chains are often required in severe, heavy-duty applications where fatigue strength is a vital factor. Years of study by Morse engineers have led to the development of the Morse® press-fit center-plate chain, the ultimate in design for long life in multiple-strand drives. Press-fitting center-plates introduces beneficial stresses into the chain which result in a greatly increased fatigue strength.

Morse press-fit center-plate chain is available on special order at no increase in price.

ROLLER CHAIN ORDERING DATA

When ordering roller chains:

1. Always indicate complete length of chain, in pitches and feet, including connecting and/or offset links required. If anything other than a single connecting link is required, it should be specified.

When connecting links or roller links are required on each end of the chain for a special application, indicate total number of pitches in the chain including type of link required on each end of the chain.

2. Bulk quantities for Roller Chains are shown on page G12

3. If a chain is required endless, indicate whether it is to be riveted endless (permanent connection) or connected with a connecting link (detachable). When an odd number of pitches are required in the chain to be connected endless, indicate whether single pitch (detachable) or two pitch (riveted) offset link is required.

*Little things make the difference
and no one puts them all together like Morse*

Morse has a true performance advantage that we prove with our precision made roller chain... and it's the little things that make the difference...

- BALLIZED LINK APERTURES
- WIDE WAISTED LINKS
- SOLID EXTRUDED BUSHING
- CUSTOMIZED SHOT PEENING
- CHAIN PRE-STRESSING
- PRECISION ASSEMBLY
- CONTROLLED PITCH
- QUAD STAKED RIVETS

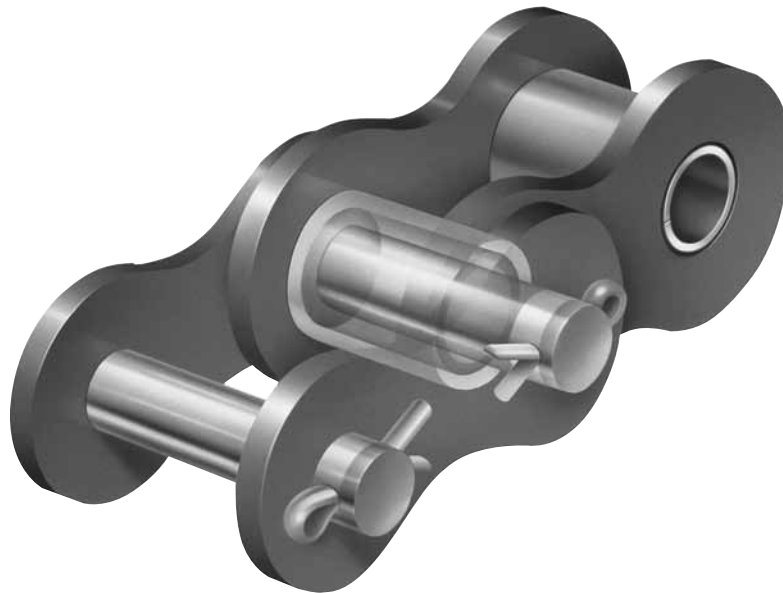

To Morse, there's nothing more important than seeing that your chain comes together in such a way that it stays together.

... a difference that will pay dividends in outstanding chain performance for years to come .

Selection of roller chain drives

- Determine the R.P.M. and diameter of the high speed shaft.
- Determine the Design H.P. to be transmitted after reference to the Table of Service Factors on Page G20.
- Select the chain pitch and number of teeth in the small sprocket from the Horsepower Rating Tables.
 - Be sure the small sprocket will accommodate the high speed shaft diameter.
 - If the high speed shaft diameter exceeds the maximum bore in the selected small sprocket it will be necessary either to increase the number of teeth in the sprocket or select the next larger pitch chain.
- Determine the required ratio:

$$\frac{\text{RPM high speed shaft}}{\text{RPM slow speed shaft}} = \text{Ratio}$$
- Multiply the number of teeth in the small sprocket by the ratio to obtain the number in the large sprocket. If a sprocket with the correct number of teeth is not listed, refer to the table, "Ratios Possible with Stock Sprockets" for the closest combination.

general recommendations on sprocket sizes

Unless speeds are low it is not advisable to use less than 15 teeth in the smaller sprocket. When ratios are low, relatively large sprockets may be used, giving less chain pull, lower bearing loads and less joint articulation. If, on the other hand, ratios and speeds are high, it may be necessary to use a relatively small number of teeth in the high-speed sprocket.

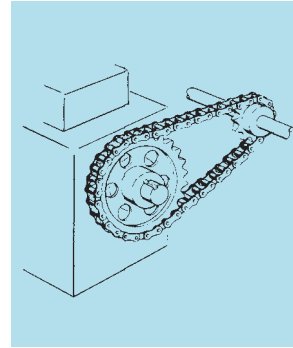

Ratios over 7:1 are generally not recommended for single roller chain drives. Very slow speed drives (10 to 100 RPM) are often practicable with as few as 9 or 10 teeth in the small sprocket, allowing ratios up to 12:1. In all cases where ratios exceed 5:1, the designer should consider the possibility of using compound drives to obtain maximum service life.

**NOTE: Contact Technical Services
for Application Assistance**

Ratios possible with Morse® stock sprockets

		number of teeth-driver sprocket																	
		9	10	11	12	13	14	15	16	17	18	19	20	21	22	23	24	25	26
number of teeth-driver sprocket	9	1.00																	
	10	1.11	1.00																
	11	1.22	1.10	1.00															
	12	1.33	1.20	1.09	1.00														
	13	1.44	1.30	1.18	1.08	1.00													
	14	1.56	1.40	1.27	1.17	1.08	1.00												
	15	1.67	1.50	1.36	1.25	1.15	1.07	1.00											
	16	1.78	1.60	1.45	1.33	1.23	1.14	1.07	1.00										
	17	1.89	1.70	1.55	1.42	1.31	1.21	1.13	1.06	1.00									
	18	2.00	1.80	1.64	1.50	1.38	1.29	1.20	1.13	1.06	1.00								
	19	2.11	1.90	1.73	1.58	1.46	1.36	1.27	1.19	1.12	1.06	1.00							
	20	2.22	2.00	1.82	1.67	1.54	1.43	1.33	1.25	1.18	1.11	1.05	1.00						
	21	2.33	2.10	1.91	1.75	1.61	1.50	1.40	1.31	1.23	1.17	1.10	1.05	1.00					
	22	2.44	2.20	2.00	1.83	1.69	1.57	1.47	1.38	1.29	1.22	1.16	1.10	1.05	1.00				
	23	2.56	2.30	2.09	1.92	1.77	1.64	1.53	1.44	1.35	1.28	1.21	1.15	1.10	1.05	1.00			
	24	2.67	2.40	2.18	2.00	1.85	1.71	1.60	1.50	1.41	1.33	1.26	1.20	1.14	1.09	1.04	1.00		
	25	2.78	2.50	2.27	2.08	1.92	1.79	1.67	1.56	1.47	1.39	1.32	1.25	1.19	1.14	1.09	1.04	1.00	
	26	2.89	2.60	2.36	2.17	2.00	1.86	1.73	1.63	1.53	1.44	1.37	1.30	1.24	1.18	1.13	1.08	1.04	1.00
	28	3.11	2.80	2.54	2.33	2.15	2.00	1.87	1.75	1.65	1.56	1.48	1.40	1.33	1.27	1.22	1.16	1.12	1.08
	30	3.33	3.00	2.73	2.50	2.31	2.14	2.00	1.88	1.76	1.67	1.58	1.50	1.43	1.36	1.30	1.25	1.20	1.15
	32	3.56	3.20	2.91	2.67	2.46	2.28	2.13	2.00	1.88	1.78	1.68	1.60	1.52	1.45	1.39	1.33	1.28	1.23
35	3.89	3.50	3.18	2.92	2.69	2.50	2.33	2.19	2.06	1.94	1.84	1.75	1.67	1.59	1.52	1.46	1.40	1.34	
36	4.00	3.60	3.27	3.00	2.77	2.57	2.40	2.25	2.12	2.00	1.89	1.80	1.72	1.64	1.56	1.50	1.44	1.38	
40	4.44	4.00	3.64	3.33	3.08	2.86	2.67	2.50	2.35	2.22	2.10	2.00	1.90	1.82	1.74	1.67	1.60	1.54	
42	4.67	4.20	3.82	3.50	3.23	3.00	2.80	2.62	2.47	2.33	2.21	2.10	2.00	1.91	1.83	1.75	1.68	1.63	
45	5.00	4.50	4.09	3.75	3.46	3.21	3.00	2.81	2.65	2.50	2.37	2.25	2.14	2.04	1.96	1.88	1.80	1.73	
48	5.33	4.80	4.36	4.00	3.69	3.43	3.20	3.00	2.82	2.67	2.52	2.40	2.28	2.18	2.10	2.00	1.92	1.84	
54	6.00	5.40	4.91	4.50	4.15	3.86	3.60	3.38	3.18	3.00	2.84	2.70	2.57	2.45	2.35	2.25	2.16	2.07	
60	6.67	6.00	5.45	5.00	4.62	4.29	4.00	3.75	3.53	3.33	3.16	3.00	2.86	2.72	2.60	2.50	2.40	2.30	
70	7.77	7.00	6.36	5.83	5.38	5.00	4.67	4.38	4.12	3.89	3.68	3.50	3.33	3.18	3.05	2.92	2.80	2.69	
72			6.55	6.00	5.55	5.14	4.80	4.50	4.24	4.00	3.79	3.60	3.43	3.27	3.13	3.00	2.88	2.77	
80			7.27	6.67	6.15	5.71	5.33	5.00	4.70	4.44	4.21	4.00	3.81	3.63	3.48	3.34	3.20	3.07	
84					6.46	6.00	5.60	5.25	4.94	4.67	4.42	4.20	4.00	3.82	3.66	3.50	3.36	3.23	
96					7.38	6.85	6.40	6.00	5.64	5.34	5.05	4.80	4.57	4.36	4.17	4.00	3.84	3.69	
112								7.00	6.59	6.23	5.89	5.60	5.33	5.08	4.87	4.67	4.48	4.30	

Service factors

The Horsepower rating tables (pages G22 thru G28) are for use under optimum drive conditions with a smooth power source and load. For less favorable conditions with moderate or heavy shock loads from either the power source and/or the load, the specified horsepower must be multiplied by a "Service Factor" (SF) to obtain a "Design Horsepower" (DHP). The "Design Horsepower" is used to obtain the chain selection from the rating tables.

Service Factors are selected below for various applications after first determining the prime mover or power source type.

Prime Mover	TYPE
Internal Combustion Engine with Hydraulic Coupling or Torque Converter	A
Electric Motor	
Turbine	
Hydraulic Motor	
Internal Combustion Engine with Mechanical Drive	B

Service factor table

APPLICATION	Type of Prime Mover		APPLICATION	Type of Prime Mover		APPLICATION	Type of Prime Mover	
	A	B		A	B		A	B
AGITATORS (paddle or propeller)			CRUSHING MACHINERY Ball mills, crushing rolls, Jaw crushers	1.6	1.8	PAPER INDUSTRY MACHINERY Agitators, bleachers	1.1	1.3
Pure Liquid	1.1	1.3	DREDGES Conveyors, cables reels Jigs & screens	1.4	1.6	Barker—mechanical	1.6	1.8
Liquids—variable density	1.2	1.4		1.6	1.8	Beater, Yankee Dryer	1.3	1.5
BAKER MACHINERY Dough Mixer	1.2	—	Cutter head drives Dredge pumps	Consult	—	Calendars, Dryer & Paper Machines	1.2	1.4
BLOWERS	See Fans			Consult	—	Chippers & winder drums	1.5	1.7
BREWING & DISTILLING EQUIPMENT Bottling Machinery	1.0	—	FANS & BLOWERS Centrifugal, propeller, vane	1.3	1.5	PRINTING MACHINERY Embossing & flat bed presses, folders	1.2	—
Brew Kettles, cookers, mash tubs	1.0	—	Positive blowers (lobe)	1.5	1.7	Paper cutter, rotary press & linotype machine	1.1	—
Scale Hopper—Frequent starts	1.2	—	GRAIN MILL MACHINERY Sifters, purifiers, separators	1.1	1.3	Magazine & newspaper presses	1.5	—
BRICK & CLAY EQUIPMENT Auger machines, cutting table	1.3	1.5	Grinders and hammer mills	1.2	1.4	PUMPS Centrifugal, gear, lobe & vane	1.2	1.4
Brick machines, dry press, & granulator	1.4	1.6	Roller mills	1.3	1.5		Dredge	1.6
Mixer, pug mill, & rolls	1.4	1.6	GENERATORS & EXCITERS	1.2	1.4	Pipeline	1.4	1.6
CENTRIFUGES	1.4	1.6	MACHINE TOOLS Grinders, lathes, drill press	1.0	—	Reciprocating		
COMPRESSORS Centrifugal & rotary (lobe)	1.1	1.3	Boring mills, milling machines	1.1	—	3 or more cyl.	1.3	1.5
Reciprocating			MARINE DRIVES	Consult	—	1 or 2 cyl.	1.6	1.8
1 or 2 cyl.	1.6	1.8	MILLS Rotary type:			RUBBER & PLASTICS INDUSTRY EQUIPMENT Calendars, rolls, tubers		
3 or more	1.3	1.5	Ball, Pebble, Rod, Tube, Roller	1.5	1.7	Tire—building and		
CONSTRUCTION EQUIPMENT OR OFF-HIGHWAY VEHICLES Drive line duty, power take-off, accessory drives	Consult	Morse	Dryers, Kilns, & tumbling barrels	1.6	1.8	Banbury Mills	1.5	1.7
CONVEYOR Apron, bucket, pan & elevator	1.4	1.6	Metal type:			Mixers and sheeters	1.6	1.8
Belt (ore, coal, sand, salt)	1.2	1.4	Draw bench carriage & main drive	1.5	—	Extruders	1.5	1.7
Belt—light package, oven	1.0	1.2	Forming Machines	Consult	—	SCREENS Conical & revolving	1.2	1.4
Screw & flight (heavy duty)	1.6	1.8	MIXERS Concrete	1.6	1.8	Rotary, gravel, stone & vibrating	1.5	1.7
CRANES & HOIST Main hoist— medium duty	1.2	1.4	Liquid & Semi-liquid	1.1	1.3	STOKERS	1.1	—
Main hoist— heavy duty, skip hoist	1.4	1.6	OIL INDUSTRY MACHINERY Compounding Units	1.1	1.3	TEST STANDS & DYNAMOMETERS	Consult	Morse
			Pipe line pumps	1.4	1.6	TEXTILE INDUSTRY Spinning frames, twisters, wrappers & reels	1.0	—
			Slush Pumps	1.5	1.7	Batchers, calendars & looms	1.1	—
			Draw works	1.8	2.0			
			Chillers, Paraffin filter presses, Kilns	1.5	1.7			

NOTE: (Relating to Service Factors)

RECOMMENDATIONS ARE MINIMUM AND NORMAL CONDITIONS ARE ASSUMED

Calculation of chain length

The following method of calculating approximate chain length may be used for both standard roller chain, silent chain, and HV drives.

1. Divide center distance in inches by pitch of chain, obtaining **C**
2. Add teeth in small sprocket to teeth in large sprocket, obtaining **S**
3. Subtract teeth in small sprocket from teeth in large sprocket, obtaining Value D. From table obtain the corresponding value of **K**
4. Chain length in pitches = $2C + \frac{S}{2} + \frac{K}{C}$
5. Chain length in feet = chain length in pitches times the pitch in inches divided by 12.

Example

Given:

Teeth in driving sprocket 21T
 Teeth in driven sprocket 60T
 Pitch of chain 1/2"
 Center distance 24"

Required:

Necessary length of chain

Solution:

- (1) $C = 24" \div 1/2 = 48$
- (2) $S = (21 + 60) = 81$
- (3) $D = (60 - 21) = 39$
corresponding **K = 38.53**
- (4) Chain length in pitches = $(2 \times 48) + \frac{81}{2} + \frac{38.53}{48} = 137.30$

The next higher whole number is 138 pitches.
(5) $138 \times 1/2 = 69"$

A chain cannot contain the fractional part of a pitch; therefore, in case the figure for the number of pitches for the chain length obtained from the use of the above formula contains a fractional part of a pitch, use the next higher whole number of pitches.

Wherever possible, use an even number of pitches in the chain length. An odd number of pitches requires the use of an offset link which is not generally desirable.

The above formula for calculating chain length cannot be used to calculate center distance dimensions.

D	K	D	K	D	K	D	K	D	K	D	K
1	.03	32	25.94	63	100.54	94	223.82	125	395.79	156	616.44
2	.10	33	27.58	64	103.75	95	228.61	126	402.14	157	624.37
3	.23	34	29.28	65	107.02	96	233.44	127	408.55	158	632.35
4	.41	35	31.03	66	110.34	97	238.33	128	415.01	159	640.38
5	.63	36	32.83	67	113.71	98	243.27	129	421.52	160	648.46
6	.91	37	34.68	68	117.13	99	248.26	130	428.08	161	656.59
7	1.24	38	36.58	69	120.60	100	253.30	131	434.69	162	664.77
8	1.62	39	38.53	70	124.12	101	258.39	132	441.36	163	673.00
9	2.05	40	40.53	71	127.69	102	263.54	133	448.07	164	681.28
10	2.53	41	42.58	72	131.31	103	268.73	134	454.83	165	689.62
11	3.06	42	44.68	73	134.99	104	273.97	135	461.64	166	698.00
12	3.65	43	46.84	74	138.71	105	279.27	136	468.51	167	706.44
13	4.28	44	49.04	75	142.48	106	284.67	137	475.42	168	714.92
14	4.96	45	51.29	76	146.31	107	290.01	138	482.39	169	723.46
15	5.70	46	53.60	77	150.18	108	295.45	139	489.41	170	732.05
16	6.48	47	55.95	78	154.11	109	300.95	140	496.47	171	740.60
17	7.32	48	58.36	79	158.09	110	306.50	141	503.59	172	749.37
18	8.21	49	60.82	80	162.11	111	312.09	142	510.76	173	758.11
19	9.14	50	63.33	81	166.19	112	317.74	143	517.98	174	766.90
20	10.13	51	65.88	82	170.32	113	323.44	144	525.25	175	775.74
21	11.17	52	68.49	83	174.50	114	329.19	145	532.57	176	784.63
22	12.26	53	71.15	84	178.73	115	334.99	146	539.94	177	793.57
23	13.40	54	73.86	85	183.01	116	340.84	147	547.36	178	802.57
24	14.59	55	76.62	86	187.34	117	346.75	148	554.83	179	811.61
25	15.83	56	79.44	87	191.73	118	352.70	149	562.36	180	820.70
26	17.12	57	82.30	88	196.16	119	358.70	150	569.93	181	829.85
27	18.47	58	85.21	89	200.64	120	364.76	151	577.56	182	839.04
28	19.86	59	88.17	90	205.18	121	370.86	152	585.23	183	848.29
29	21.30	60	91.19	91	209.76	122	377.02	153	592.96	184	857.58
30	22.80	61	94.25	92	214.40	123	383.22	154	600.73	185	866.93
31	24.34	62	97.37	93	219.08	124	389.48	155	608.56

WARNING - Failure to install drives properly can reduce service life and may result in breakage.

Roller chain drive selection

In the selection of a chain drive, the horsepower to be transmitted and the size and speed of the faster running shaft are known specified quantities. The designer must select chain and sprocket sizes that will satisfy all the requirements. It must be determined whether single or multiple strand chain best fits the application. Also, the maximum speed, of the chain, for long service life, must be kept within the limits given in the horsepower rating tables.

The horsepower rating tables are used to make a precise selection and to determine the number of teeth required for the small sprocket.

The ratings in the horsepower tables are for single strand chains. Consequently, in order to use the tables for multiple strand chain selections, the required horsepower table rating per strand must be calculated from the following equation:

$$\text{Req'd HP rating tables} = \frac{\text{Design HP}}{\text{Multiple Strand Factor}}$$

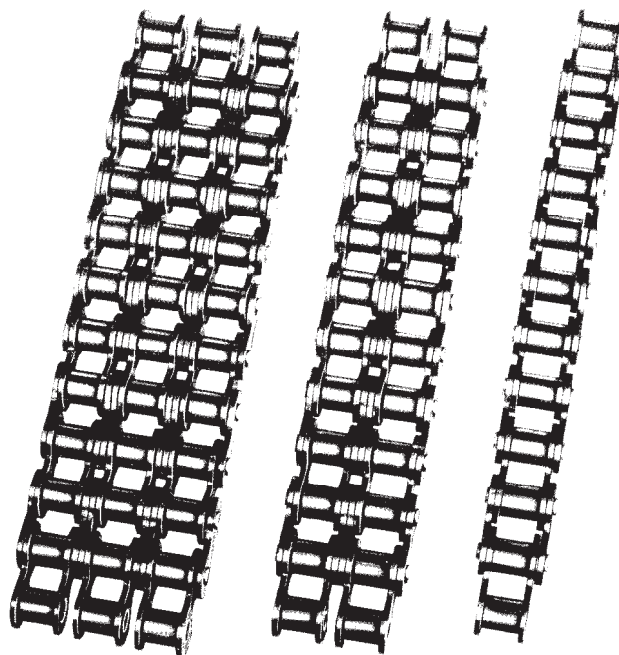

No.25-1/4" pitch standard single strand roller chain

No. of Teeth Small Spkt.	Revolutions per Minute-Small Sprocket																								
	50	100	300	500	700	900	1200	1500	1800	2100	2500	3000	3500	4000	4500	5000	5500	6000	6500	7000	7500	8000	8500	9000	10000
12	0.03	0.06	0.16	0.25	0.34	0.43	0.55	0.68	0.80	0.92	1.07	1.26	1.45	1.57	1.32	1.12	0.97	0.86	0.76	0.68	0.61	0.56	0.51	0.47	0.40
13	0.04	0.06	0.17	0.27	0.37	0.47	0.60	0.74	0.87	1.00	1.17	1.38	1.58	1.77	1.49	1.27	1.10	0.96	0.86	0.77	0.69	0.63	0.57	0.53	0.45
14	0.04	0.07	0.19	0.30	0.40	0.50	0.65	0.80	0.94	1.08	1.27	1.49	1.71	1.93	1.66	1.42	1.23	1.08	0.96	0.86	0.77	0.70	0.64	0.59	0.50
15	0.04	0.07	0.20	0.32	0.43	0.54	0.70	0.86	1.01	1.17	1.36	1.61	1.85	2.08	1.84	1.57	1.36	1.20	1.06	0.95	0.86	0.78	0.71	0.65	0.56
16	0.04	0.08	0.22	0.34	0.47	0.58	0.76	0.92	1.09	1.25	1.46	1.72	1.98	2.23	2.03	1.73	1.50	1.32	1.17	1.05	0.94	0.86	0.78	0.72	0.61
17	0.05	0.08	0.23	0.37	0.50	0.62	0.81	0.99	1.16	1.33	1.56	1.84	2.11	2.38	2.22	1.90	1.64	1.44	1.28	1.14	1.03	0.94	0.86	0.79	0.67
18	0.05	0.09	0.25	0.39	0.53	0.66	0.86	1.05	1.24	1.42	1.66	1.96	2.25	2.53	2.42	2.07	1.79	1.57	1.39	1.25	1.12	1.02	0.93	0.86	0.73
19	0.05	0.09	0.26	0.41	0.56	0.70	0.91	1.11	1.31	1.50	1.76	2.07	2.38	2.69	2.62	2.24	1.94	1.70	1.51	1.35	1.22	1.11	1.01	0.93	0.79
20	0.06	0.10	0.28	0.44	0.59	0.74	0.96	1.17	1.38	1.59	1.86	2.19	2.52	2.84	2.83	2.42	2.10	1.84	1.63	1.46	1.32	1.20	1.09	1.00	0.86
21	0.06	0.11	0.29	0.46	0.62	0.78	1.01	1.24	1.46	1.68	1.96	2.31	2.66	2.99	3.05	2.60	2.26	1.98	1.76	1.57	1.42	1.29	1.17	1.08	0.92
22	0.06	0.11	0.31	0.48	0.66	0.82	1.07	1.30	1.53	1.76	2.06	2.43	2.79	3.15	3.27	2.79	2.42	2.12	1.88	1.69	1.52	1.38	1.26	1.16	0.99
23	0.06	0.12	0.32	0.51	0.69	0.86	1.12	1.37	1.61	1.85	2.16	2.55	2.93	3.30	3.50	2.98	2.59	2.27	2.01	1.80	1.62	1.47	1.35	1.24	1.06
24	0.07	0.13	0.34	0.53	0.72	0.90	1.17	1.43	1.69	1.94	2.27	2.67	3.07	3.46	3.73	3.18	2.76	2.42	2.15	1.92	1.73	1.57	1.44	1.32	1.12
25	0.07	0.13	0.35	0.56	0.75	0.94	1.22	1.50	1.76	2.02	2.37	2.79	3.21	3.61	3.96	3.38	2.93	2.57	2.28	2.04	1.84	1.67	1.53	1.40	1.20
26	0.07	0.14	0.37	0.58	0.79	0.98	1.28	1.56	1.84	2.11	2.47	2.91	3.34	3.77	4.19	3.59	3.11	2.73	2.42	2.17	1.95	1.77	1.62	1.49	1.27
28	0.08	0.15	0.40	0.63	0.85	1.07	1.38	1.69	1.99	2.29	2.68	3.15	3.62	4.09	4.54	4.01	3.47	3.05	2.70	2.42	2.18	1.98	1.81	1.66	1.42
30	0.08	0.16	0.43	0.68	0.92	1.15	1.49	1.82	2.15	2.46	2.88	3.40	3.90	4.40	4.89	4.45	3.85	3.38	3.00	2.68	2.42	2.20	2.01	1.84	1.57
32	0.09	0.17	0.46	0.73	0.98	1.23	1.60	1.95	2.30	2.64	3.09	3.64	4.18	4.72	5.25	4.90	4.25	3.73	3.30	2.96	2.67	2.42	2.21	2.03	1.73
35	0.10	0.19	0.51	0.80	1.08	1.36	1.76	2.15	2.53	2.91	3.41	4.01	4.61	5.20	5.78	5.60	4.86	4.26	3.78	3.38	3.05	2.77	2.53	2.32	1.98
40	0.12	0.22	0.58	0.92	1.25	1.57	2.03	2.48	2.93	3.36	3.93	4.64	5.32	6.00	6.68	6.85	5.93	5.21	4.62	4.13	3.73	3.38	3.09	2.83	2.42
45	0.13	0.25	0.66	1.05	1.42	1.78	2.31	2.82	3.32	3.82	4.47	5.26	6.05	6.82	7.58	8.17	7.08	6.21	5.51	4.93	4.45	4.04	3.69	3.38	2.89
	TYPE A						TYPE B						TYPE C												

TYPE A: Manual or Drip Lubrication (500 fpm max.)

TYPE B: Bath or Disc Lubrication (3500 fpm max.)

TYPE C: Oil Stream Lubrication (Up to max. speed shown).

The limiting RPM for each lubrication type is read from the column to the left of the boundary line shown.

For Multi-Strand Chain use

No. of Strands	Strand Factor
2	1.7
3	2.5
4	3.3

"CAUTION: RELATIVE TO APPLICATIONS INVOLVING THE HANDLING OF PEOPLE, MORSE ENGINEERING MUST BE CONSULTED PRIOR TO DRIVE SELECTION."

No. 35-3/8" pitch standard single strand roller chain

No. of Teeth Small Spkt.	Revolutions per Minute-Small Sprocket																								
	50	100	300	500	700	900	1200	1500	1800	2100	2500	3000	3500	4000	4500	5000	5500	6000	6500	7000	7500	8000	8500	9000	10000
12	0.11	0.20	0.54	0.85	1.15	1.44	1.87	2.29	2.70	3.10	3.62	3.35	2.66	2.17	1.82	1.56	1.35	1.18	1.05	0.94	0.85	0.77	0.70	0.64	0.55
13	0.12	0.22	0.59	0.93	1.26	1.57	2.04	2.49	2.94	3.38	3.95	3.77	3.00	2.45	2.05	1.75	1.52	1.33	1.18	1.06	0.95	0.87	0.79	0.73	0.62
14	0.13	0.24	0.63	1.01	1.36	1.71	2.21	2.70	3.18	3.66	4.28	4.22	3.35	2.74	2.30	1.96	1.70	1.49	1.32	1.18	1.07	0.97	0.88	0.81	0.69
15	0.14	0.25	0.68	1.08	1.47	1.84	2.38	2.91	3.43	3.94	4.61	4.68	3.71	3.04	2.55	2.17	1.88	1.65	1.47	1.31	1.18	1.07	0.98	0.90	0.77
16	0.15	0.27	0.73	1.16	1.57	1.97	2.55	3.12	3.68	4.22	4.94	5.15	4.09	3.35	2.81	2.40	2.08	1.82	1.62	1.45	1.30	1.18	1.08	0.99	0.85
17	0.16	0.29	0.78	1.24	1.68	2.10	2.73	3.33	3.93	4.51	5.28	5.64	4.48	3.67	3.07	2.62	2.27	2.00	1.77	1.58	1.43	1.30	1.18	1.09	0.93
18	0.17	0.31	0.83	1.32	1.78	2.24	2.90	3.54	4.18	4.80	5.61	6.15	4.88	3.99	3.35	2.86	2.48	2.17	1.93	1.73	1.56	1.41	1.29	1.18	1.01
19	0.18	0.33	0.88	1.40	1.89	2.37	3.07	3.76	4.43	5.09	5.95	6.67	5.29	4.33	3.63	3.10	2.69	2.36	2.09	1.87	1.69	1.53	1.40	1.28	1.10
20	0.19	0.35	0.93	1.48	2.00	2.51	3.25	3.97	4.68	5.38	6.29	7.20	5.72	4.68	3.92	3.35	2.90	2.55	2.26	2.02	1.82	1.65	1.51	1.39	1.18
21	0.20	0.37	0.98	1.56	2.11	2.64	3.42	4.19	4.93	5.67	6.63	7.75	6.15	5.03	4.22	3.60	3.12	2.74	2.43	2.17	1.96	1.78	1.62	1.49	1.27
22	0.21	0.38	1.03	1.64	2.22	2.78	3.60	4.40	5.19	5.96	6.97	8.21	6.59	5.40	4.52	3.86	3.35	2.94	2.61	2.33	2.10	1.91	1.74	1.60	1.37
23	0.22	0.40	1.08	1.72	2.33	2.92	3.78	4.62	5.44	6.25	7.31	8.62	7.05	5.77	4.83	4.13	3.58	3.14	2.79	2.49	2.25	2.04	1.86	1.71	1.46
24	0.23	0.42	1.14	1.80	2.44	3.05	3.96	4.84	5.70	6.55	7.66	9.02	7.51	6.15	5.15	4.40	3.81	3.35	2.97	2.66	2.40	2.17	1.99	1.82	1.56
25	0.24	0.44	1.19	1.88	2.55	3.19	4.13	5.05	5.95	6.84	8.00	9.43	7.99	6.54	5.48	4.68	4.05	3.56	3.16	2.82	2.55	2.31	2.11	1.94	1.65
26	0.25	0.46	1.24	1.96	2.66	3.33	4.31	5.27	6.21	7.14	8.35	9.84	8.47	6.93	5.81	4.96	4.30	3.77	3.35	3.00	2.70	2.45	2.24	2.05	1.75
28	0.27	0.50	1.34	2.12	2.88	3.61	4.67	5.71	6.73	7.73	9.05	10.7	9.47	7.75	6.49	5.55	4.81	4.22	3.74	3.35	3.02	2.74	2.50	2.30	1.96
30	0.29	0.54	1.45	2.29	3.10	3.89	5.03	6.15	7.25	8.33	9.74	11.5	10.5	8.59	7.20	6.15	5.33	4.68	4.15	3.71	3.35	3.04	2.77	2.55	2.17
32	0.31	0.58	1.55	2.45	3.32	4.17	5.40	6.60	7.77	8.93	10.4	12.3	11.6	9.47	7.93	6.77	5.87	5.15	4.57	4.09	3.69	3.35	3.06	2.81	0
35	0.34	0.64	1.71	2.70	3.66	4.59	5.95	7.27	8.56	9.84	11.5	13.6	13.2	10.8	9.08	7.75	6.72	5.90	5.23	4.68	4.22	3.83	3.50	3.21	0
40	0.39	0.73	1.97	3.12	4.23	5.30	6.87	8.40	9.89	11.4	13.3	15.7	16.2	13.2	11.1	9.47	8.21	7.20	6.39	5.72	5.15	4.68	0		
45	0.45	0.83	2.24	3.55	4.80	6.02	7.80	9.53	11.2	12.9	15.1	17.8	19.3	15.8	13.2	11.3	9.79	8.59	7.62	6.82	0				
	TYPE A						TYPE B						TYPE C												

TYPE A: Manual Drip or Lubrication (370 fpm max.)

TYPE B: Bath or Disc Lubrication (2800 fpm max.)

TYPE C: Oil Stream Lubrication (Up to max. speed shown).

No. 40-1/2" pitch standard single strand roller chain

No. of Teeth Small Spkt.	Revolutions per Minute-Small Sprocket																								
	10	25	50	100	200	300	400	500	700	900	1000	1200	1400	1600	1800	2100	2400	2700	3000	3500	4000	5000	6000	7000	8000
12	0.08	0.18	0.34	0.64	1.19	1.72	2.22	2.72	3.68	4.62	5.07	5.98	6.87	6.34	5.31	4.22	3.45	2.89	2.47	1.96	1.60	1.15	0.87	0.69	0.57
13	0.09	0.20	0.37	0.70	1.30	1.87	2.43	2.96	4.01	5.03	5.53	6.52	7.49	7.15	5.99	4.76	3.89	3.26	2.79	2.21	1.81	1.29	0.98	0.78	0.64
14	0.09	0.22	0.40	0.75	1.41	2.03	2.63	3.21	4.35	5.45	5.99	7.06	8.11	7.99	6.70	5.31	4.35	3.65	3.11	2.47	2.02	1.45	1.10	0.87	0.71
15	0.10	0.23	0.44	0.81	1.52	2.18	2.83	3.46	4.68	5.87	6.46	7.61	8.74	8.86	7.43	5.89	4.82	4.04	3.45	2.74	2.24	1.60	1.22	0.97	0.79
16	0.11	0.25	0.47	0.87	1.63	2.34	3.03	3.71	5.02	6.30	6.92	8.16	9.37	9.76	8.18	6.49	5.31	4.45	3.80	3.02	2.47	1.77	1.34	1.07	0.87
17	0.12	0.27	0.50	0.93	1.74	2.50	3.24	3.96	5.36	6.72	7.39	8.71	10.01	10.69	8.96	7.11	5.82	4.88	4.17	3.31	2.71	1.94	1.47	1.17	0.96
18	0.12	0.28	0.53	0.99	1.85	2.66	3.45	4.21	5.70	7.15	7.86	9.26	10.64	11.65	9.76	7.75	6.34	5.31	4.54	3.60	2.95	2.11	1.60	1.27	0
19	0.13	0.30	0.56	1.05	1.96	2.82	3.65	4.47	6.05	7.58	8.33	9.82	11.28	12.64	10.59	8.40	6.88	5.76	4.92	3.91	3.20	2.29	1.74	1.38	0
20	0.14	0.32	0.59	1.11	2.07	2.98	3.86	4.72	6.39	8.01	8.81	10.38	11.93	13.45	11.44	9.07	7.43	6.22	5.31	4.22	3.45	2.47	1.88	1.49	0
21	0.15	0.34	0.63	1.17	2.18	3.14	4.07	4.98	6.74	8.45	9.29	10.94	12.57	14.18	12.30	9.76	7.99	6.70	5.72	4.54	3.71	2.66	2.02	1.60	0
22	0.15	0.35	0.66	1.23	2.29	3.30	4.28	5.23	7.08	8.88	9.76	11.51	13.22	14.91	13.19	10.47	8.57	7.18	6.13	4.87	3.98	2.85	2.17	1.72	0
23	0.16	0.37	0.69	1.29	2.41	3.47	4.49	5.49	7.43	9.32	10.24	12.07	13.87	15.64	14.10	11.19	9.16	7.68	6.55	5.20	4.26	3.05	2.32	1.84	0
24	0.17	0.39	0.72	1.35	2.52	3.63	4.70	5.75	7.78	9.76	10.73	12.64	14.52	16.37	15.03	11.93	9.76	8.18	6.99	5.54	4.54	3.25	2.47	1.96	0
25	0.18	0.41	0.76	1.41	2.63	3.79	4.91	6.01	8.13	10.20	11.21	13.21	15.18	17.11	15.98	12.68	10.38	8.70	7.43	5.89	4.82	3.45	2.63	0	
26	0.19	0.42	0.79	1.47	2.75	3.96	5.13	6.27	8.48	10.64	11.70	13.78	15.83	17.85	16.95	13.45	11.01	9.23	7.88	6.25	5.12	3.66	2.79	0	
28	0.20	0.46	0.85	1.60	2.98	4.29	5.55	6.79	9.19	11.52	12.67	14.93	17.15	19.34	18.94	15.03	12.30	10.31	8.80	6.99	5.72	4.09	3.11	0	
30	0.22	0.49	0.92	1.72	3.21	4.62	5.98	7.31	9.90	12.42	13.65	16.08	18.48	20.84	21.01	16.67	13.65	11.44	9.76	7.75	6.34	4.54	3.45	0	
32	0.23	0.53	0.99	1.84	3.44	4.95	6.42	7.84	10.62	13.31	14.64	17.25	19.81	22.34	23.14	18.37	15.03	12.60	10.76	8.54	6.99	5.00	0		
35	0.26	0.58	1.09	2.03	3.79	5.46	7.07	8.64	11.70	14.66	16.12	19.00	21.82	24.61	26.47	21.01	17.20	14.41	12.30	9.76	7.99	5.72	0		
40	0.30	0.67	1.26	2.34	4.38	6.30	8.16	9.98	13.51	16.94	18.62	21.94	25.21	28.43	31.61	25.67	21.01	17.61	15.03	11.93	9.76	6.99	0		
45	0.34	0.76	1.43	2.66	4.97	7.16	9.27	11.33	15.34	19.24	21.15	24.92	28.63	32.29	35.90	30.63	25.07	21.01	17.94	14.23	11.65	0			
	TYPE A						TYPE B						TYPE C												

TYPE A: Manual Drip or Lubrication (300 fpm max.)

TYPE B: Bath or Disc Lubrication (2300 fpm max.)

TYPE C: Oil Stream Lubrication (Up to max. speed shown).

The limiting RPM for each lubrication type is read from the column to the left of the boundary line shown.

The ratings on this page are in accordance with the standards of the American Chain Association, Copyright 1974.

For Multi-Strand Chain use

No. of Strands	Strand Factor
2	1.7
3	2.5
4	3.3

**No. 41-1/2" pitch light weight machinery chain
standard single strand roller chain**

No. of Teeth Small Spkt.	Revolutions per Minute-Small Sprocket																								
	10	25	50	100	200	300	400	500	700	900	1000	1200	1400	1600	1800	2100	2400	2700	3000	3500	4000	5000	6000	7000	8000
12	0.03	0.07	0.14	0.26	0.49	0.70	0.91	1.11	1.50	1.88	2.07	1.95	1.55	1.27	1.06	0.84	0.69	0.58	0.49	0.39	0.32	0.23	0.17	0.14	0.11
13	0.04	0.08	0.15	0.28	0.53	0.76	0.99	1.21	1.63	2.05	2.25	2.20	1.75	1.43	1.20	0.95	0.78	0.65	0.56	0.44	0.36	0.26	0.20	0.16	0.13
14	0.04	0.09	0.16	0.31	0.57	0.83	1.07	1.31	1.77	2.22	2.44	2.46	1.95	1.60	1.34	1.06	0.87	0.73	0.62	0.49	0.40	0.29	0.22	0.17	0.14
15	0.04	0.09	0.18	0.33	0.62	0.89	1.15	1.41	1.91	2.39	2.63	2.73	2.17	1.77	1.49	1.18	0.96	0.81	0.69	0.55	0.45	0.32	0.24	0.19	0.16
16	0.04	0.10	0.19	0.36	0.66	0.95	1.24	1.51	2.05	2.57	2.82	3.01	2.39	1.95	1.64	1.30	1.06	0.89	0.76	0.60	0.49	0.35	0.27	0.21	0.17
17	0.05	0.11	0.20	0.38	0.71	1.02	1.32	1.61	2.18	2.74	3.01	3.29	2.61	2.14	1.79	1.42	1.16	0.98	0.83	0.66	0.54	0.39	0.29	0.23	0.19
18	0.05	0.12	0.22	0.40	0.75	1.08	1.40	1.72	2.32	2.91	3.20	3.59	2.85	2.33	1.95	1.55	1.27	1.06	0.91	0.72	0.59	0.42	0.32	0.25	0
19	0.05	0.12	0.23	0.43	0.80	1.15	1.49	1.82	2.46	3.09	3.40	3.89	3.09	2.53	2.12	1.68	1.38	1.15	0.98	0.78	0.64	0.46	0.35	0.28	0
20	0.06	0.13	0.24	0.45	0.84	1.21	1.57	1.92	2.60	3.26	3.59	4.20	3.33	2.73	2.29	1.81	1.49	1.24	1.06	0.84	0.69	0.49	0.38	0.30	0
21	0.06	0.14	0.26	0.48	0.89	1.28	1.66	2.03	2.74	3.44	3.78	4.46	3.59	2.94	2.46	1.95	1.60	1.34	1.14	0.91	0.74	0.53	0.40	0.32	0
22	0.06	0.14	0.27	0.50	0.93	1.35	1.74	2.13	2.89	3.62	3.98	4.69	3.85	3.15	2.64	2.09	1.71	1.44	1.23	0.97	0.80	0.57	0.43	0.34	0
23	0.06	0.15	0.28	0.53	0.98	1.41	1.83	2.24	3.03	3.80	4.17	4.92	4.11	3.37	2.82	2.24	1.83	1.54	1.31	1.04	0.85	0.61	0.46	0.37	0
24	0.07	0.16	0.29	0.55	1.03	1.48	1.92	2.34	3.17	3.97	4.37	5.15	4.38	3.59	3.01	2.39	1.95	1.64	1.40	1.11	0.91	0.65	0.49	0.39	0
25	0.07	0.17	0.31	0.57	1.07	1.55	2.00	2.45	3.31	4.15	4.57	5.38	4.66	3.81	3.20	2.54	2.08	1.74	1.49	1.18	0.96	0.69	0.53	0	0
26	0.07	0.17	0.32	0.60	1.12	1.61	2.09	2.55	3.46	4.33	4.76	5.61	4.94	4.05	3.39	2.69	2.20	1.85	1.58	1.25	1.02	0.73	0.56	0	0
28	0.08	0.19	0.35	0.65	1.21	1.75	2.26	2.77	3.74	4.69	5.16	6.08	5.52	4.52	3.79	3.01	2.46	2.06	1.76	1.40	1.14	0.82	0.62	0	0
30	0.08	0.20	0.38	0.70	1.31	1.88	2.44	2.98	4.03	5.06	5.53	6.55	6.13	5.01	4.20	3.33	2.73	2.29	1.95	1.55	1.27	0.91	0.69	0	0
32	0.09	0.22	0.40	0.75	1.40	2.02	2.61	3.20	4.33	5.42	5.96	7.03	6.75	5.52	4.63	3.67	3.01	2.52	2.15	1.71	1.40	1.00	0	0	0
35	0.10	0.24	0.44	0.83	1.54	2.22	2.88	3.52	4.76	5.97	6.57	7.74	7.72	6.32	5.29	4.20	3.44	2.88	2.46	1.95	1.60	1.14	0	0	0
40	0.12	0.27	0.51	0.96	1.78	2.57	3.33	4.07	5.50	6.90	7.59	8.94	9.43	7.72	6.47	5.13	4.20	3.52	3.01	2.39	1.95	1.40	0	0	0
45	0.14	0.31	0.58	1.08	2.02	2.92	3.78	4.62	6.25	7.84	8.62	10.2	11.3	9.21	7.72	6.13	5.01	4.20	3.59	2.85	2.33	0	0	0	0
	TYPE A							TYPE B							TYPE C										

TYPE A: Manual Drip or Lubrication (500 fpm max.)

TYPE B: Bath or Disc Lubrication (3500 fpm max.)

TYPE C: Oil Stream Lubrication (Up to max. speed shown).

No. 50-5/8" pitch standard single strand roller chain

No. of Teeth Small Spkt.	Revolutions per Minute-Small Sprocket																								
	10	25	50	100	200	300	400	500	700	900	1000	1200	1400	1600	1800	2100	2400	2700	3000	3500	4000	4500	5000	5500	6000
12	0.16	0.36	0.67	1.24	2.32	3.34	4.33	5.29	7.16	8.98	9.87	11.63	9.26	7.58	6.35	5.04	4.13	3.46	2.95	2.34	1.92	1.61	1.37	1.19	1.04
13	0.17	0.39	0.73	1.36	2.53	3.64	4.72	5.77	7.81	9.79	10.77	12.68	10.44	8.55	7.16	5.69	4.65	3.90	3.33	2.64	2.16	1.81	1.55	1.34	0
14	0.18	0.42	0.79	1.47	2.74	3.95	5.11	6.25	8.46	10.61	11.66	13.74	11.67	9.55	8.01	6.35	5.20	4.36	3.72	2.95	2.42	2.03	1.73	1.50	0
15	0.20	0.45	0.85	1.58	2.95	4.25	5.51	6.73	9.11	11.43	12.56	14.80	12.94	10.60	8.88	7.05	5.77	4.83	4.13	3.27	2.68	2.25	1.92	1.66	0
16	0.21	0.49	0.91	1.70	3.16	4.56	5.91	7.22	9.77	12.25	13.47	15.87	14.26	11.67	9.78	7.76	6.35	5.32	4.55	3.61	2.95	2.47	2.11	1.83	0
17	0.23	0.52	0.97	1.81	3.38	4.87	6.31	7.71	10.43	13.08	14.38	16.95	15.62	12.78	10.71	8.50	6.96	5.83	4.98	3.95	3.23	2.71	2.31	2.01	0
18	0.24	0.55	1.03	1.93	3.59	5.18	6.71	8.20	11.10	13.91	15.30	18.03	17.02	13.93	11.67	9.26	7.58	6.35	5.42	4.30	3.52	2.95	2.52	0	0
19	0.26	0.59	1.09	2.04	3.81	5.49	7.11	8.69	11.77	14.75	16.22	19.11	18.45	15.10	12.66	10.05	8.22	6.89	5.88	4.67	3.82	3.20	2.73	0	0
20	0.27	0.62	1.16	2.16	4.03	5.80	7.52	9.19	12.44	15.59	17.14	20.20	19.93	16.31	13.67	10.85	8.88	7.44	6.35	5.04	4.13	3.46	2.95	0	0
21	0.29	0.65	1.22	2.27	4.25	6.11	7.92	9.68	13.11	16.44	18.07	21.29	21.44	17.55	14.71	11.67	9.55	8.01	6.84	5.42	4.44	3.72	3.18	0	0
22	0.30	0.69	1.28	2.39	4.46	6.43	8.33	10.18	13.78	17.28	19.00	22.39	22.99	18.82	15.77	12.52	10.24	8.59	7.33	5.82	4.76	3.99	3.41	0	0
23	0.32	0.72	1.34	2.51	4.68	6.75	8.74	10.68	14.46	18.13	19.94	23.49	24.58	20.12	16.86	13.38	10.95	9.18	7.84	6.22	5.09	4.27	0	0	0
24	0.33	0.75	1.41	2.63	4.90	7.06	9.15	11.19	15.14	18.98	20.87	24.60	26.20	21.44	17.97	14.26	11.67	9.78	8.35	6.63	5.42	4.55	0	0	0
25	0.35	0.79	1.47	2.75	5.12	7.38	9.56	11.69	15.82	19.84	21.81	25.70	27.85	22.80	19.11	15.16	12.41	10.40	8.88	7.05	5.77	4.83	0	0	0
26	0.36	0.82	1.54	2.87	5.35	7.70	9.98	12.20	16.51	20.70	22.76	26.82	29.54	24.18	20.26	16.08	13.16	11.03	9.42	7.47	6.12	5.13	0	0	0
28	0.39	0.89	1.66	3.10	5.79	8.34	10.81	13.21	17.88	22.42	24.65	29.05	33.01	27.02	22.65	17.97	14.71	12.33	10.52	8.35	6.84	5.73	0	0	0
30	0.42	0.96	1.79	3.34	6.24	8.99	11.64	14.23	19.27	24.16	26.56	31.30	35.96	29.97	25.11	19.93	16.31	13.67	11.67	9.26	7.58	0	0	0	0
32	0.45	1.03	1.92	3.59	6.69	9.64	12.48	15.26	20.66	25.90	28.48	33.56	38.55	33.01	27.67	21.96	17.97	15.06	12.86	10.20	8.35	0	0	0	0
35	0.50	1.13	2.12	3.95	7.37	10.62	13.75	16.81	22.76	28.53	31.47	36.97	42.47	37.76	31.65	25.11	20.56	17.23	14.71	11.67	9.55	0	0	0	0
40	0.57	1.31	2.44	4.56	8.51	12.26	15.89	19.42	26.29	32.96	36.24	42.70	49.06	46.14	38.67	30.68	25.11	21.05	17.97	14.26	0	0	0	0	0
45	0.65	1.49	2.78	5.18	9.67	13.93	18.04	22.05	29.86	37.43	41.16	48.49	55.71	55.05	46.14	36.61	29.97	25.11	21.44	0	0	0	0	0	0
	TYPE A							TYPE B							TYPE C										

TYPE A: Manual Drip or Lubrication (500 fpm max.)

TYPE B: Bath or Disc Lubrication (3500 fpm max.)

TYPE C: Oil Stream Lubrication (Up to max. speed shown).

The limiting RPM for each lubrication type is read from the column to the left of the boundary line shown.

The ratings on this page are in accordance with the standards of the American Chain Association, Copyright 1974.

For Multi-Strand Chain use

No. of Strands	Strand Factor
2	1.7
3	2.5
4	3.3



ANSI ROLLER CHAIN
HORSEPOWER RATINGS

No. 140-1 3/4" pitch standard single strand roller chain

Table with columns: No. of Teeth Small Spk., Spkt., and Revolutions per Minute - Small Sprocket (10-1700). Rows 12-45. Includes TYPE A, B, and C labels at the bottom.

TYPE A: Manual Drip or Lubrication (300 fpm max.)
TYPE B: Bath or Disc Lubrication (2300 fpm max.)
TYPE C: Oil Stream Lubrication (Up to max. speed shown).
The limiting RPM for each Lubrication type is read from the column to the left to the boundary line shown.
Speeds within shaded area - consider Morse HV.

No. 160-2" pitch standard single strand roller chain

Table with columns: No. of Teeth Small Spk., Spkt., and Revolutions per Minute - Small Sprocket (10-1400). Rows 12-45. Includes TYPE A, B, and C labels at the bottom.

TYPE A: Manual or Drip Lubrication (300 fpm max.)
TYPE B: Bath or Disc Lubrication (2300 fpm max.)
TYPE C: Oil Stream Lubrication (Up to max. speed shown).
The limiting RPM for each Lubrication type is read from the column to the left to the boundary line shown.
For optimum results, it is recommended that the roller Chain manufacturer be given the opportunity to evaluate the conditions of operation of chains in the speeds within dotted lines (galling range).
The ratings on this page are in accordance with the standards of the American Chain Association, Copyright 1974
Speeds within shaded area - consider Morse HV.

Table: For Multi. Strand Chain use. Columns: No. of Strands, Strand Factor. Rows: 2, 3, 4, 5, 6, 8.

No. 200-2 1/2" pitch standard single strand roller chain

No. of Teeth Small Spkt.	Revolutions per Minute - Small Sprocket																			
	10	15	20	30	40	50	70	100	150	200	250	300	350	400	450	500	550	600	650	700
9	4.99	7.19	9.31	13.42	17.38	21.25	28.76	39.65	57.11	73.98	90.44	106.57	122.43	119.42	100.08	85.45	74.07	65.00	57.65	0
10	5.59	8.06	10.44	15.03	19.48	23.81	32.23	44.43	63.99	82.90	101.34	119.41	137.18	139.87	117.21	100.08	86.75	76.13	67.52	0
11	6.20	8.93	11.57	16.66	21.59	26.39	35.72	49.24	70.93	91.89	112.33	132.36	152.05	161.36	135.23	115.46	100.08	87.83	77.90	0
12	6.81	9.81	12.71	18.30	23.71	28.99	39.24	54.09	77.92	100.94	123.39	145.40	167.04	183.86	154.08	131.56	114.03	100.08	0	0
13	7.42	10.69	13.86	19.96	25.86	31.61	42.78	58.98	84.95	110.06	134.54	158.53	182.12	205.37	173.74	148.34	128.58	112.85	0	0
14	8.04	11.59	15.01	21.62	28.01	34.24	46.35	63.89	92.03	119.23	145.75	171.74	197.29	222.49	194.17	165.78	143.70	126.11	0	0
15	8.67	12.48	16.17	23.29	30.18	36.89	49.93	68.84	99.15	128.45	157.02	185.02	212.56	239.70	215.34	183.86	159.37	139.87	0	0
16	9.29	13.38	17.34	24.97	32.35	39.55	53.54	73.80	106.31	137.72	168.36	198.38	227.90	257.00	237.23	202.55	175.56	154.08	0	0
17	9.92	14.29	18.51	26.66	34.54	42.23	57.16	78.80	113.50	147.04	179.75	211.80	243.32	274.39	259.81	221.83	192.28	168.75	0	0
18	10.55	15.20	19.69	28.36	36.74	44.92	60.80	83.82	120.73	156.41	191.19	225.29	258.81	291.86	283.07	241.69	209.49	183.86	0	0
19	11.19	16.11	20.87	30.07	38.95	47.62	64.46	88.86	127.99	165.81	202.69	238.83	274.38	309.41	306.98	262.11	227.19	199.39	0	0
20	11.82	17.03	22.06	31.78	41.17	50.33	68.13	93.92	135.28	175.26	214.24	252.44	290.01	327.04	331.53	283.07	245.36	0	0	0
21	12.46	17.95	23.26	33.50	43.40	53.05	71.82	99.00	142.60	184.74	225.83	266.10	305.70	344.73	356.71	304.56	263.99	0	0	0
22	13.11	18.88	24.46	35.23	45.64	55.79	75.52	104.10	149.94	194.26	237.46	279.81	321.45	362.50	382.49	326.57	283.07	0	0	0
23	13.75	19.81	25.66	36.96	47.88	58.53	79.23	109.22	157.32	203.81	249.14	293.57	337.26	380.32	408.86	349.09	302.59	0	0	0
24	14.40	20.74	26.87	38.70	50.13	61.28	82.96	114.36	164.72	213.40	260.86	307.38	353.12	398.21	435.81	372.10	322.53	0	0	0
25	15.05	21.67	28.08	40.44	52.39	64.04	86.70	119.51	172.14	223.02	272.62	321.23	369.04	416.16	462.70	395.60	342.90	0	0	0
26	15.70	22.61	29.29	42.19	54.66	66.82	90.45	124.68	179.59	232.67	284.41	335.13	385.00	434.17	482.72	419.57	363.68	0	0	0
	TYPE A					TYPE B					TYPE C									

TYPE A: Manual Drip or Lubrication (300 fpm max.)

TYPE B: Bath or Disc Lubrication (2300 fpm max.)

TYPE C: Oil Stream Lubrication (Up to max. speed shown).

The limiting RPM for each Lubrication type is read from the column to the left to the boundary line shown.

Speeds within shaded area - consider Morse HV.

No. 240-3" pitch standard single strand roller chain

No. of Teeth Small Spkt.	Revolutions per Minute - Small Sprocket																				
	5	10	15	20	25	30	40	50	60	80	100	125	150	175	200	250	300	350	400	450	500
9	3.92	7.31	10.5	13.6	16.7	19.6	25.4	31.1	36.7	47.5	58.1	71.0	83.6	96.1	108	132	156	169	138	116	0
10	4.39	8.19	11.8	15.3	18.7	22.0	28.5	34.9	41.1	53.2	65.0	79.5	93.7	108	121	148	175	198	162	136	0
11	4.86	9.08	13.1	16.9	20.7	24.4	31.6	38.6	45.5	59.0	72.1	88.1	104	119	135	164	194	223	187	156	0
12	5.34	9.97	14.4	18.6	22.7	26.8	34.7	42.4	50.0	64.8	79.2	96.8	114	131	148	181	213	245	218	0	0
13	5.83	10.9	15.7	20.3	24.8	29.2	37.9	46.3	54.5	70.6	86.4	106	124	143	161	197	232	267	240	0	0
14	6.31	11.8	17.0	22.0	26.9	31.7	41.0	50.1	59.1	76.5	93.6	114	135	155	175	213	251	289	268	0	0
15	6.80	12.7	18.3	23.7	28.9	34.1	44.2	54.0	63.6	82.4	101	123	145	167	188	230	271	311	297	0	0
16	7.29	13.6	19.6	25.4	31.0	36.6	47.4	57.9	68.2	88.4	108	132	156	179	202	247	290	334	328	0	0
17	7.78	14.5	20.9	27.1	33.1	39.0	50.6	61.8	72.9	94.4	115	141	166	191	215	263	310	356	359	0	0
18	8.28	15.4	22.3	28.8	35.2	41.5	53.8	65.8	77.5	100	123	150	177	203	229	280	330	379	377	0	0
19	8.78	16.4	23.6	30.6	37.4	44.0	57.0	69.7	82.2	106	130	159	187	215	243	297	350	402	393	0	0
20	9.28	17.3	24.9	32.3	39.5	46.5	60.3	73.7	86.8	112	138	168	198	228	257	314	370	423	407	0	0
21	9.78	18.2	26.3	34.1	41.6	49.0	63.5	77.7	91.5	119	145	177	209	240	270	331	390	439	421	0	0
22	10.3	19.2	27.6	35.8	43.8	51.6	66.8	81.7	96.2	125	152	186	220	252	284	348	410	454	435	0	0
23	10.8	20.1	29.0	37.6	45.9	54.1	70.1	85.7	101	131	160	195	230	265	298	365	430	469	448	0	0
24	11.3	21.1	30.4	39.3	48.1	56.7	73.4	89.7	106	137	167	205	241	277	312	382	450	483	0	0	0
25	11.8	22.0	31.7	41.1	50.3	59.2	76.7	93.8	110	143	175	214	252	290	327	399	470	496	0	0	0
26	12.3	23.0	33.1	42.9	52.4	61.8	80.0	97.8	115	149	183	223	263	302	341	416	491	509	0	0	0
	TYPE A					TYPE B					TYPE C										

TYPE A: Manual Drip or Lubrication (75 fpm max.)

TYPE B: Bath or Disc Lubrication (800 fpm max.)

TYPE C: Oil Stream Lubrication (Up to max. speed shown).

The limiting RPM for each Lubrication type is read from the column to the left to the boundary line shown.

The ratings on this page are in accordance with the standards of the American Chain Association, Copyright 1974

Speeds within shaded area - consider Morse HV.

For Multi-Strand Chain use	
No. of Strands	Strand Factor
2	1.7
3	2.5
4	3.3
5	3.9
6	4.6
8	6.0

Roller chains at high temperatures

Roller Chains made of conventional materials lose some of their valuable characteristics at elevated temperatures. Depending on the temperature of service, part or all of the properties built into the chains by the initial heat treatment of the components are lost:

1. The hardness and, therefore, the wear resistance of pins and bushings are reduced.
2. At temperatures above 700°F, the rollers and plates lose hardness and strength.

In addition to this alteration in hardness, both material strength and load capacity of the chain are lowered considerably by operation at temperatures above 700°F.

Use standard steel roller chain at temperatures up to 500°F with the following adjustments in capacity ratings:

Temperature	Percent of Catalog Capacity Rating
Up to 350°F	100%
400	75
500	50

These limits on capacity are based on the tendency for pins and bushings to gall and the softening of wear surfaces. They are not based on a loss of tensile strength, as oddly enough, the strength of the side plates increases when tested at temperatures up to 500°F. Because of this tendency to gall, make special provisions for lubrication.

Use 18-8 stainless steel chains up to 800°F; however, between 200°F and 800°F reduce the ratings as shown in the following table:

Temperature	Percent of Catalog Capacity Stainless Steel Chain Rating
200°F	86%
300	79
350	77
400	77
500	77
600	77
700	77
800	73

Chain tools



Roller chain tool (for pin removal)

Morse Tool Number	Part Number	Roller Chain Sizes		Wt.
		Nos.	Pitches Inclusive	
25-60	2360964	25 thru 60	3/8 to 3/4	0.61
60-100	2360972	60 thru 100	3/4 to 1 1/4	1.50
120-160	2361004	120 thru 160	1 1/2 to 2	8.30



Standard hook-up tool

For These Chain Types	Pitch	
HV Drive	3/4, 1	1 1/2, 2
Silent		
Roller	3/4, 1, 1 1/4	1 1/2, 1 3/4, 2, 2 1/2
Width Range inches	1 1/2" - 12"	3" - 12"
Tool Number	097726	097756

This Roller Chain Tool reduces time, both in the field and shop, required for disconnecting roller chains of bulk length to cut length, chain repair and alteration.

All parts of this tool are of machine finished steel, with moving parts hardened for maximum strength and wear resistance—a tool requiring a minimum of maintenance

- **Portable**
- **Simple Design**
- **Field Proven**
- **Time Saver**
- **Proven**
- **Dependability**
- **Quality**

Roller chain performance is dependent on interference fits of the component parts and these brief instructions are intended to guide an individual toward safe practices that will not abuse the designed integrity of the roller chain.

When connecting or disconnecting chain, a chain tool is preferred, but if it is unavailable, or impractical, an appropriate

Recommended disassembly procedure

Prepare pins for removal by removing cotters, clips, or, for rivet type chain, grind the rivet end flush with the link plate. Avoid overheating when grinding.

1. Prepare pins for removal by removing cotters, clips, or, for rivet type chain, grind the rivet end flush with the link plate. Avoid overheating when grinding.
2. Support the chain in a holding device, or secure it to a sprocket, and press or drive the pins out, alternating the strokes, so that the pin link moves out evenly and does not damage the adjacent roller unit bushings.
3. Examine the exposed roller units to be sure they are not damaged. The bushings should still be fully assembled in the roller link plates.

Recommended assembly procedures

The field connection of chain is accomplished through use of appropriate connecting links.

1. Arrange the chain on a solid surface, or secure over a sprocket, and insert the pins of connecting link into the ends of the chain.
2. Place the free pin link plate over the pin ends.
3. Use a hollow punch to press, or tap, the pin link plate onto the pin ends.
4. Insert the appropriate fastening device.
5. **AFTER ASSEMBLY:** make sure the joint moves freely.

hammer and punches can be substituted. It will also be useful, to utilize a chain vice, or similar holding device, to secure and support the chain in place. (See "Roller Chain Tools" at bottom on page G29). The rework of chain must utilize complete, unaltered, sub assemblies of roller links and pin links of the type shown on page G11.

CAUTION

WHEN CONNECTING/DISCONNECTING CHAIN

1. Always lock out equipment power switch before removing or installing chains.
2. Always **USE SAFETY GLASSES** to protect your eyes.
3. Wear protective clothing, gloves and safety shoes as appropriate.
4. **SUPPORT THE CHAIN TO PREVENT UNCONTROLLED MOVEMENT OF CHAIN AND PARTS. REMOVE COTTER KEYS OR GRIND OFF RIVETED PIN END**
5. **USE OF PRESSING EQUIPMENT IS RECOMMENDED. TOOLS MUST BE IN GOOD CONDITION AND PROPERLY USED.**
6. **DO NOT ATTEMPT TO CONNECT OR DISCONNECT CHAIN UNLESS YOU KNOW THE CHAIN CONSTRUCTION.**
7. Damaged chain may be weakened and therefore should not be reworked.
8. Discard removed components. Components should not be reused.
9. Use **NEW** sub-assemblies for rework and not individual components.

CONSULT MANUFACTURER OR AUTHORIZED DISTRIBUTOR FOR COMPLETE ASSEMBLY OR DISASSEMBLY PROCEDURES

Chain pullers (for installing roller chain)

Puller No.	Part No.	Chain Size	Jaw Spread	Weight
35	2361020	No. 35 to 60	2"	5 oz.
80	2361038	No. 80 to 240	3 1/2"	1 lb.

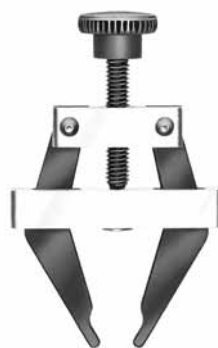

No. 35



No. 80

This unique tool was designed to make roller chain installation quick and easy. In fact, it's almost like having a third hand.

To use the Morse chain puller: (1) hook the two jaws into each end of the chain; (2) turn the screw until the two ends almost meet; (3) insert the connecting link and fasten.



A New Age for an Enduring Legend... Attachment Chain

Quality chain which continues to be second to none

Breadth of attachment line - 35 to 160, C2040 to C2122

Made-to order capabilities

Modern attachment cell to service you

Price competitive with anyone in the industry

Delivery to meet your requirements

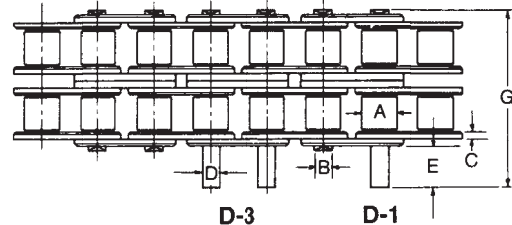
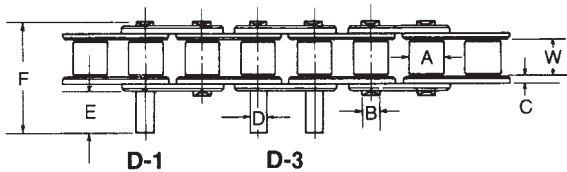

ANSI roller chain-extended pins

Chain No.	Pitch	Roller Width W	Dimensions (Inches)							
			Roller Diam. A	Chain Pin Diam. B	Side Plate Thickness C	Diameter of Extended Pins D	Standard Length of Extended Pins E	F	G	H
† 35 & 35-2	3/8	3/16	.200	.141	.050	.141	3/8	13/16	1 7/32	.350
41	1/2	1/4	.306	.141	.050	.141	3/8	55/64	—	.383
40 & 40-2	1/2	5/16	.312	.156	.060	.156	3/8	31/32	1 17/32	.466
50 & 50-2	5/8	3/8	.400	.200	.080	.200	15/32	1 7/32	1 15/16	.584
60 & 60-2	3/4	1/2	.468	.234	.094	.234	9/16	1 1/2	2 13/32	.700
80 & 80-2	1	5/8	.625	.312	.125	.312	3/4	1 31/32	3 1/8	.934
100 & 100-2	1 1/4	3/4	.750	.375	.156	.375	15/16	2 27/64	3 53/64	1.166
120 & 120-2	1 1/2	1	.875	.437	.187	.437	1 1/8	3	4 25/32	1.400
140 & 140-2	1 3/4	1	1.000	.500	.219	.500	1 5/16	3 21/64	5 1/4	1.634
160 & 160-2	2	1 1/4	1.125	.562	.250	.562	1 1/2	3 29/32	6 7/32	1.866

† Rollerless

All sizes available in Riveted construction. Sizes 60 and above available in Cottered construction. Please specify desired construction when ordering.

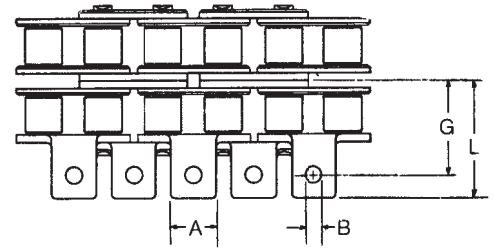
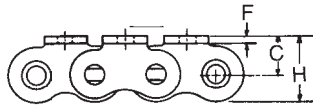
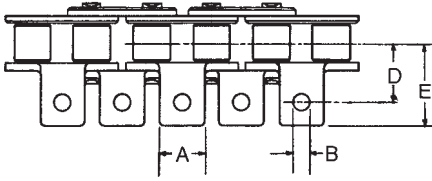
B-1 bent attachments ANSI roller chain

Chain No.	Pitch	Roller			Dimensions (Inches)									Chain Wt. Per Ft. (Lbs.) Single	Chain Wt. Per Ft. (Lbs.) Double	Each B-1 Attach. Wt. (Lbs.)
		Width	Diam.	Pin Diam.	A	B	C	D	E	F	G	H-Inside Plate Height	L			
† 35 & 35-2	3/8	3/16	.200	.141	5/16	7/64	1/4	3/8	17/32	.050	37/64	27/64	47/64	.21	.40	.002
41	1/2	1/4	.306	.141	3/8	1/8	9/32	15/32	11/16	.050	—	15/32	—	.25	—	.003
40 & 40-2	1/2	5/16	.312	.156	3/8	9/64	5/16	1/2	23/32	.060	25/32	35/64	1	.42	.82	.003
50 & 50-2	5/8	3/8	.400	.200	1/2	13/64	13/32	5/8	29/32	.080	63/64	45/64	1 17/64	.69	1.36	.008
60 & 60-2	3/4	1/2	.468	.234	5/8	13/64	15/32	3/4	1 5/64	.094	1 13/34	13/16	1 17/32	1.00	1.99	.013
80 & 80-2	1	5/8	.625	.312	3/4	17/64	5/8	1	1 25/64	.125	1 37/64	1 3/32	1 31/32	1.71	3.40	.027
100 & 100-2	1 1/4	3/4	.750	.375	1	21/64	25/32	1 1/4	1 11/16	.156	1 61/64	1 23/64	2 25/64	2.50	5.10	.055
120 & 120-2	1 1/2	1	.875	.437	1 1/8	25/64	29/32	1 1/2	2 1/6	.187	2 25/64	1 39/64	2 61/64	3.87	7.65	.082
140 & 140-2	1 3/4	1	1.000	.500	1 3/8	29/64	1 1/8	1 3/4	2 17/64	.219	2 23/32	1 15/16	3 15/64	4.95	9.80	.141
160 & 160-2	2	1 1/4	1.125	.562	1 1/2	33/64	1 1/4	2	2 11/16	.250	3 5/32	2 3/16	3 27/32	6.61	13.10	.198

† Rollerless

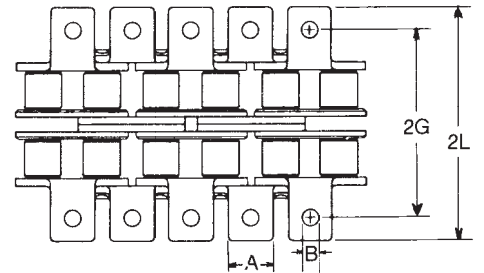
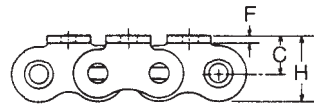
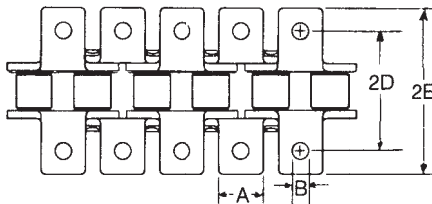
B-2 bent attachments ANSI roller chain

Chain No.	Pitch	Roller			Dimensions (Inches)									Chain Wt. Per Ft. (Lbs.) Single	Chain Wt. Per Ft. (Lbs.) Double	Each B-2 Attach. Wt. (Lbs.)
		Width	Diam.	Pin Diam.	A	B	C	2D	2E	F	2G	H-Inside Plate Height	2L			
† 35 & 35-2	3/8	3/16	.200	.141	5/16	7/64	1/4	3/4	1 1/16	.050	1 5/32	27/64	1 1/2	.21	.40	.004
41	1/2	1/4	.306	.141	3/8	1/8	5/16	15/16	1 3/8	.050	—	15/32	—	.25	—	.006
40 & 40-2	1/2	5/16	.312	.156	3/8	9/64	5/16	1	1 7/16	.060	1 9/16	35/64	2	.42	.82	.006
50 & 50-2	5/8	3/8	.400	.200	1/2	13/64	13/32	1 1/4	1 13/16	.080	1 31/32	45/64	2 17/32	.69	1.36	.016
60 & 60-2	3/4	1/2	.468	.234	5/8	13/64	15/32	1 1/2	2 5/32	.094	2 13/32	13/16	3 1/16	1.00	1.99	.026
80 & 80-2	1	5/8	.625	.312	3/4	17/64	5/8	2	2 25/32	.125	3 5/32	1 3/32	3 15/16	1.71	3.40	.054
100 & 100-2	1 1/4	3/4	.750	.375	1	21/64	25/32	2 1/2	3 3/8	.156	3 29/32	1 23/64	4 25/32	2.58	5.10	.110
120 & 120-2	1 1/2	1	.875	.437	1 1/8	25/64	29/32	3	4 1/8	.187	4 25/32	1 39/64	5 29/32	3.87	7.65	.164
140 & 140-2	1 3/4	1	1.000	.500	1 3/8	29/64	1 1/8	3 1/2	4 17/32	.219	5 7/16	1 15/16	6 15/32	4.95	9.80	.282
160 & 160-2	2	1 1/4	1.125	.562	1 1/2	33/64	1 1/4	4	5 3/8	.250	6 5/16	2 3/16	7 11/16	6.61	13.10	.396

† Rollerless

All sizes available in Riveted construction. Sizes 60 and above available in Cottered construction. Please specify desired construction when ordering.

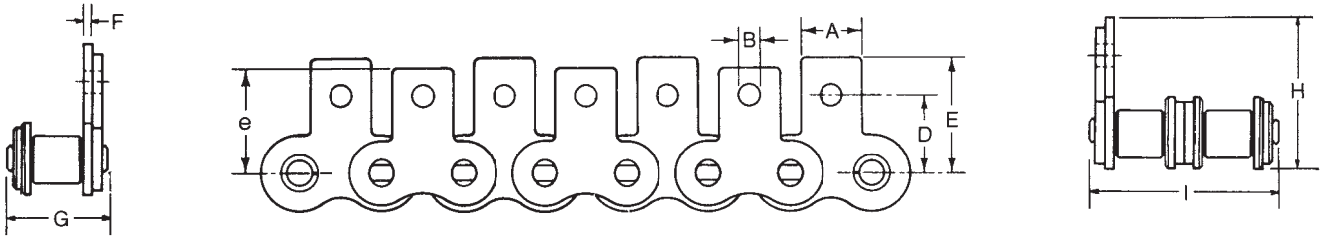

S-1 straight attachments ANSI roller chain

Chain No.	Pitch	Roller		Pin Diam.	Dimensions (Inches)									Chain Wt. Per Ft. (Lbs.) Single	Chain Wt. Per Ft. (Lbs.) Double	Each S-1 Attach. Wt. (Lbs.)
		Width	Diam.		A	B	D	e	E	F	G	H-Inside Plate Height	I			
† 35 & 35-2	3/8	3/16	.200	.141	5/16	7/64	3/8	17/32	17/32	.050	.466	45/64	.866	.21	.40	.002
41	1/2	1/4	.306	.141	3/8	1/8	31/64	45/64	45/64	.050	.512	57/64	—	.25	—	.003
40 & 40-2	1/2	5/16	.312	.156	3/8	9/64	1/2	11/16	3/4	.060	.630	63/64	1.194	.42	.82	.003
50 & 50-2	5/8	3/8	.400	.200	1/2	13/64	5/8	57/64	31/32	.080	.790	1 17/64	1.507	.69	1.36	.008
60 & 60-2	3/4	1/2	.468	.234	5/8	13/64	23/32	1 1/32	1 1/8	.094	.990	1 15/32	1.893	1.00	1.99	.013
80 & 80-2	1	5/8	.625	.312	3/4	17/64	31/32	1 11/32	1 1/2	.125	1.274	1 31/32	2.432	1.71	3.40	.027
100 & 100-2	1 1/4	3/4	.750	.375	1	21/64	1 1/4	1 21/32	1 53/64	.156	1.555	2 13/32	2.963	2.58	5.10	.055
120 & 120-2	1 1/2	1	.875	.437	1 1/8	25/64	1 7/16	1 15/16	2 1/8	.187	1.960	2 53/64	3.749	3.87	7.65	.082
140 & 140-2	1 3/4	1	1.000	.500	1 3/8	29/64	1 3/4	2 9/32	2 1/2	.219	2.117	3 5/16	4.041	4.95	9.80	.141
160 & 160-2	2	1 1/4	1.125	.562	1 1/2	32/64	2	2 39/64	2 7/8	.250	2.522	3 13/16	4.827	6.61	13.10	.198

† Rollerless

G

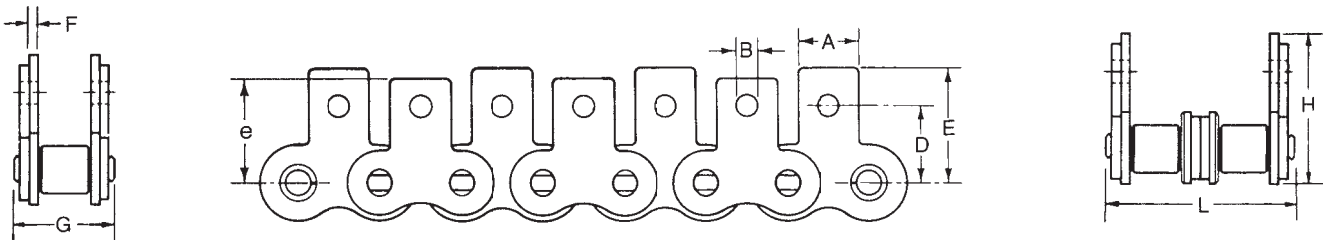

S-2 straight attachments ANSI roller chain

Chain No.	Pitch	Roller		Pin Diam.	Dimensions (Inches)									Chain Wt. Per Ft. (Lbs.) Single	Chain Wt. Per Ft. (Lbs.) Double	Each S-2 Attach. Wt. (Lbs.)
		Width	Diam.		A	B	D	e	E	F	G	H-Inside Plate Height	I			
† 35 & 35-2	3/8	3/16	.200	.141	5/16	7/64	3/8	17/32	17/32	.050	.466	45/64	.866	.21	.40	.004
41	1/2	1/4	.306	.141	3/8	1/8	31/64	45/64	45/64	.050	.512	57/64	—	.25	—	.006
40 & 40-2	1/2	5/16	.312	.156	3/8	9/64	1/2	11/16	3/4	.060	.630	63/64	1.194	.42	.82	.006
50 & 50-2	5/8	3/8	.400	.200	1/2	13/64	5/8	57/64	31/32	.080	.790	1 17/64	1.507	.69	1.36	.016
60 & 60-2	3/4	1/2	.468	.234	5/8	13/64	23/32	1 1/32	1 1/8	.094	.990	1 15/32	1.893	1.00	1.99	.026
80 & 80-2	1	5/8	.625	.312	3/4	17/64	31/32	1 11/32	1 1/2	.125	1.274	1 31/32	2.432	1.71	3.40	.054
100 & 100-2	1 1/4	3/4	.750	.375	1	21/64	1 1/4	1 21/32	1 53/64	.156	1.555	2 13/32	2.963	2.58	5.10	.110
120 & 120-2	1 1/2	1	.875	.437	1 1/8	25/64	1 7/16	1 15/16	2 1/8	.187	1.960	2 53/64	3.749	3.87	7.65	.164
140 & 140-2	1 3/4	1	1.000	.500	1 3/8	29/64	1 3/4	2 9/32	2 1/2	.219	2.117	3 5/16	4.041	4.95	9.80	.282
160 & 160-2	2	1 1/4	1.125	.562	1 1/2	33/64	2	2 39/64	2 7/8	.250	2.522	3 13/16	4.827	6.61	13.10	.396

† Rollerless

All sizes available in Riveted construction. Sizes 60 and above available in Cottered construction. Please specify desired construction when ordering.

No. 2050 1 1/4" double pitch roller chain

No. of Teeth	Effective No. of Teeth	Pitch Diam.	Revolutions per Minute - Small Sprocket																
			25	50	100	150	200	250	300	350	400	450	500	550	600	650	700	750	800
17	8 1/2	3.460	.28	.52	.90	1.40	1.43												
19	9 1/2	3.850	.33	.60	1.06	1.43	1.74	2.0	2.2										
21	10 1/2	4.241	.37	.68	1.22	1.66	2.04	2.37	2.63	2.86	3.07								
23	11 1/2	4.633	.41	.76	1.37	1.88	2.33	2.72	3.05	3.34	3.61	3.83							
25	12 1/2	5.026	.45	.84	1.52	2.09	2.60	3.06	3.45	3.80	4.13	4.39	4.60						
26	13	5.223	.47	.88	1.59	2.20	2.74	3.23	3.65	4.03	4.38	4.66	4.90	5.11	5.30				
28	14	5.617	.51	.95	1.73	2.41	3.01	3.55	4.02	4.45	4.85	5.17	5.47	5.73	5.95	6.09			
30	15	6.012	.55	1.02	1.87	2.62	3.27	3.87	4.37	4.86	5.30	5.67	6.01	6.31	6.57	6.75	6.94		
32	16	6.407	.58	1.09	2.01	2.82	3.52	4.17	4.72	5.25	5.73	6.15	6.53	6.87	7.17	7.39	7.61	7.79	
34	17	6.803	.62	1.17	2.14	3.01	3.77	4.46	5.07	5.67	6.15	6.61	7.05	7.42	7.74	7.99	8.24	8.46	8.62
35	17 1/2	7.001	.64	1.20	2.20	3.10	3.89	4.60	5.24	5.85	6.35	6.84	7.29	7.68	8.01	8.27	8.54	8.77	8.95
36	18	7.198	.66	1.24	2.27	3.20	4.01	4.75	5.41	6.04	6.56	7.07	7.54	7.95	8.29	8.56	8.84	9.08	9.28
38	19	7.595	.70	1.31	2.40	3.39	4.25	5.04	5.75	6.40	6.96	7.51	8.01	8.46	8.82	9.12	9.42	9.68	9.90
40	20	7.991	.74	1.38	2.53	3.57	4.48	5.32	6.07	6.75	7.35	7.94	8.46	8.94	9.33	9.65	9.97	10.25	10.49
Manual drip or bath lubrication.									Rapid drip, bath or slinger disc lubrication.									Slinger disc or pump lubrication.	

No. 2060 1 1/2" double pitch roller chain

No. of Teeth	Effective No. of Teeth	Pitch Diam.	Revolutions per Minute - Small Sprocket																	
			25	50	75	100	125	150	175	200	225	250	275	300	350	400	450	500	550	600
17	8 1/2	4.152	.48	.87	1.19	1.48	1.73	1.94	2.12											
19	9 1/2	4.620	.55	1.01	1.40	1.75	2.06	2.34	2.59	2.81	3.0									
21	10 1/2	5.089	.62	1.14	1.61	2.02	2.38	2.73	3.03	3.32	3.56	3.81	4.01	4.19						
23	11 1/2	5.560	.69	1.27	1.80	2.28	2.69	3.10	3.46	3.82	4.10	4.41	4.65	4.90	5.32					
25	12 1/2	6.032	.76	1.40	1.99	2.53	3.0	3.47	3.87	4.29	4.62	4.99	5.28	5.57	6.08	6.49				
26	13	6.268	.79	1.47	2.09	2.66	3.15	3.65	4.08	4.52	4.88	5.27	5.59	5.91	6.46	6.92	7.25			
28	14	6.741	.86	1.60	2.27	2.90	3.45	4.00	4.48	4.96	5.37	5.80	6.17	6.54	7.17	7.72	8.10	8.51		
30	15	7.215	.92	1.72	2.45	3.14	3.74	4.34	4.86	5.39	5.85	6.32	6.73	7.14	7.86	8.48	8.92	9.40		
32	16	7.689	.99	1.85	2.64	3.37	4.02	4.67	5.24	5.81	6.32	6.82	7.27	7.72	8.52	9.21	9.71	10.25	10.70	
34	17	8.163	1.05	1.97	2.82	3.59	4.29	4.99	5.61	6.22	6.78	7.32	7.80	8.29	9.16	9.91	10.47	11.06	11.59	11.99
35	17 1/2	8.401	1.08	2.03	2.91	3.70	4.42	5.15	5.79	6.42	7.0	7.56	8.06	8.56	9.47	10.24	10.84	11.45	12.0	12.43
36	18	8.638	1.12	2.10	3.00	3.82	4.56	5.31	5.97	6.63	7.23	7.81	8.32	8.84	9.78	10.58	11.21	11.84	12.42	12.88
38	19	9.113	1.18	2.22	3.17	4.04	4.83	5.62	6.32	7.03	7.67	8.29	8.83	9.38	10.38	11.23	11.93	12.60	13.22	13.73
40	20	9.589	1.25	2.34	3.34	4.26	5.09	5.93	6.67	7.42	8.09	8.74	9.33	9.91	10.96	11.86	12.62	13.34	13.99	14.54
Manual drip or bath lubrication.									Rapid drip, bath or slinger disc lubrication.											

No. 2080 2" double pitch roller chain

No. of Teeth	Effective No. of Teeth	Pitch Diam.	Revolutions per Minute - Small Sprocket																	
			10	20	30	40	50	60	70	80	90	100	125	150	175	200	225	250	300	350
17	8 1/2	5.536	.49	.91	1.28	1.63	1.94	2.23	2.51	2.76	2.99									
19	9 1/2	6.160	.55	1.04	1.48	1.89	2.27	2.62	2.96	3.27	3.57	3.84	4.46	4.99						
21	10 1/2	6.785	.62	1.17	1.67	2.14	2.59	3.01	3.39	3.77	4.11	4.46	5.22	5.89	6.48					
23	11 1/2	7.413	.69	1.30	1.86	2.39	2.92	3.38	3.81	4.26	4.65	5.06	5.96	6.76	7.46	8.11	8.67			
25	12 1/2	8.042	.75	1.43	2.05	2.64	3.23	3.73	4.23	4.73	5.18	5.64	6.67	7.60	8.42	9.19	9.84	10.45		
26	13	8.357	.79	1.49	2.15	2.77	3.38	3.91	4.44	4.97	5.45	5.93	7.02	8.02	8.89	9.72	10.42	11.08		
28	14	8.988	.85	1.62	2.33	3.01	3.67	4.26	4.85	5.42	5.96	6.49	7.69	8.82	9.80	10.74	11.53	12.29	13.60	
30	15	9.620	.91	1.74	2.52	3.25	3.96	4.60	5.25	5.86	6.45	7.03	8.34	9.60	10.68	11.73	12.60	13.46	14.94	
32	16	10.252	.98	1.87	2.70	3.48	4.24	4.94	5.64	6.29	6.93	7.56	8.98	10.36	11.53	12.69	13.63	14.59	16.24	17.65
34	17	10.885	1.04	1.99	2.88	3.71	4.52	5.28	6.02	6.72	7.40	8.09	9.61	11.10	12.36	13.62	14.63	15.69	17.50	19.04
35	17 1/2	11.201	1.07	2.05	2.96	3.82	4.66	5.44	6.21	6.93	7.63	8.34	9.92	11.46	12.77	14.07	15.11	16.22	18.11	19.71
36	18	11.518	1.11	2.11	3.05	3.94	4.80	5.61	6.40	7.14	7.87	8.60	10.23	11.82	13.18	14.52	15.60	16.76	18.72	20.38
38	19	12.151	1.17	2.23	3.23	4.17	5.08	5.94	6.77	7.56	8.33	9.10	10.84	12.52	13.98	15.39	16.55	17.80	19.90	21.67
40	20	12.785	1.23	2.35	3.40	4.40	5.35	6.26	7.13	7.98	8.78	9.60	11.44	13.20	14.76	16.24	17.48	18.81	21.04	22.91
Manual, drip or bath lubrication.													Rapid drip, bath or slinger disc lubrication.							

Conveyor series

Conveyor series double pitch roller chain has heavy series thickness sideplates with full contact edges for longer wear. This style chain was designed especially for conveyor applications where the chain will slide over a surface. Conveyor series is also available with large rollers to eliminate normal sliding friction losses.



Conveyor series-standard rollers

Chain No.	Dimensions (Inches)								Wt. Per Ft. Lbs.	Av. Ult. Strength Lbs.
	Pitch	Roller		Pin Diam. C	Pin Length		Side Plate			
		Diam. D	Width W		Riveted L	Cotter M	Height H	Thick F		
C-2040	1	.312	5/16	.156	.630	.700†	.466	.060	.34	3,700
C-2050	1 1/4	.400	3/8	.200	.790	.870†	.584	.080	.56	6,100
C-2060H	1 1/2	.468	1/2	.234	1.115	1.207	.700	.125	1.01	8,500
C-2080H	2	.625	5/8	.312	1.400	1.504	.934	.156	1.67	14,500
C-2100H	2 1/2	.750	3/4	.375	1.684	1.828	1.166	.187	2.47	24,000
C-2120H	3	.875	1	.437	2.090	2.259	1.400	.219	3.56	34,000

† 1" and 1 1/4" pitches are stocked in rivet type only. Cottered pin length is pin length for connecting link.

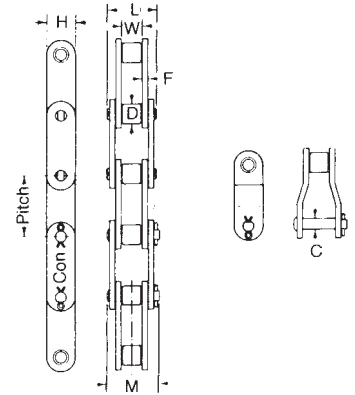

Conveyor series-large rollers

Chain No.	Dimensions (Inches)								Wt. Per Ft. Lbs.	Av. Ult. Strength Lbs.
	Pitch	Roller		Pin Diam. C	Pin Length		Side Plate			
		Diam. D	Width W		Riveted L	Cotter M	Height H	Thick F		
C-2042	1	.625	5/16	.156	.630	.700	.466	.060	.58	3,700
C-2052	1 1/4	.750	3/8	.200	.790	.870	.584	.080	.88	6,100
C-2062H	1 1/2	.875	1/2	.234	1.115	1.207	.700	.125	1.48	8,500
C-2062H-T*	1 1/2	.875	1/2	.234	1.115	1.207	.700	.125	1.00	8,500
C-2082H	2	1.125	5/8	.312	1.400	1.504	.934	.156	2.40	14,500
C-2102H	2 1/2	1.562	3/4	.375	1.684	1.828	1.166	.187	3.96	24,000
C-2122H	3	1.750	1	.437	2.090	2.259	1.400	.219	5.56	34,000

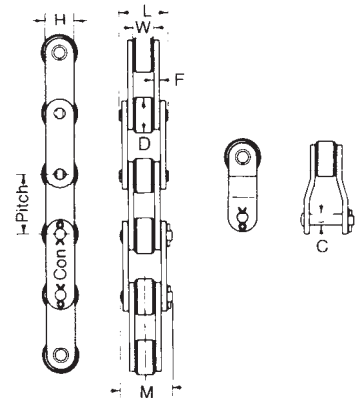

Conveyor series-extended pins

Chain No.	Dimensions (Inches)							
	Pitch	Roller Width	Roller			Side Plate Thickness C	Diam. of Extended Pin D	Length of Pin Ext. E
			Roller Diam. A	Chain Pin Diam. B	Side Plate Thickness C			
Standard Roller								
C-2040	1	5/16	.312	.156	.060	.156	3/8	
C-2050	1 1/4	3/8	.400	.200	.080	.200	15/32	
C-2060H	1 1/2	1/2	.468	.234	.125	.234	9/16	
C-2080H	2	5/8	.625	.312	.156	.312	3/4	
C-2100H	2 1/2	3/4	.750	.375	.187	.375	15/16	
C-2120H	3	1	.875	.437	.219	.437	1 1/8	
Large Rollers								
C-2042	1	5/16	.625	.156	.060	.156	3/8	
C-2052	1 1/4	3/8	.750	.200	.080	.200	15/32	
C-2062H	1 1/2	1/2	.875	.234	.125	.234	9/16	
C-2062H-T*	1 1/2	1/2	.875	.234	.125	.234	9/16	
C-2082H	2	5/8	1.125	.312	.156	.312	3/4	
C-2102H	2 1/2	3/4	1.562	.375	.187	.375	15/16	
C-2122H	3	1	1.750	.437	.219	.437	1 1/8	

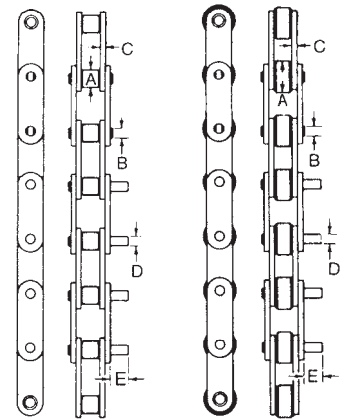

Standard Rollers Large Rollers

Chains on this page should not be used for Hoisting applications. Consult Technical Services for Hoist application recommendations.

Conveyor series - standard rollers bent attachments

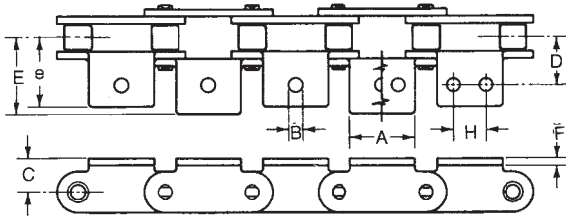

B-1

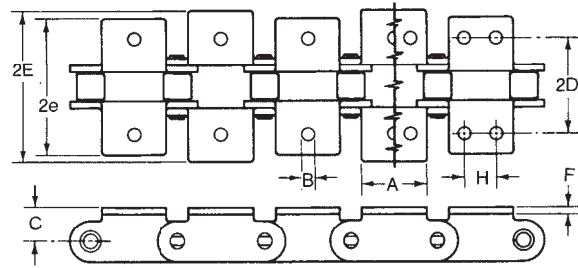

B-2

Chain No.	Pitch	Dimensions (Inches)													Weight In Lbs.			
		Roller		Pin Diam.	A	B+	C	D	2D	Over Roller Link		Over Pin Link		F	H	Chain Per Foot	Each Attach.	
		Width	Diam.							e	2e	E	2E				B-1	B-2
C-2040	1	5/16	.312	.156	3/4	9/64	23/64	1/2	1	11/16	1 3/8	49/64	1 17/32	.060	3/8	.34	.004	.008
C-2050	1 1/4	3/8	.400	.200	1	13/64	7/16	5/8	1 1/4	29/32	1 13/16	63/64	1 31/32	.080	15/32	.56	.014	.028
C-2060H	1 1/2	1/2	.468	.234	1 1/8	13/64	37/64	27/32	1 11/16	1 5/64	2 5/32	1 13/64	2 13/32	.125	9/16	1.01	.035	.070
C-2080H	2	5/8	.625	.312	1 1/2	17/64	3/4	1 3/32	2 3/16	1 13/32	2 13/16	1 9/16	3 1/8	.156	3/4	1.67	.074	.148
C-2100H	2 1/2	3/4	.750	.375	1 7/8	21/64	59/64	1 5/16	2 5/8	1 25/32	3 9/16	1 31/32	3 15/16	.187	15/16	2.47	.132	.264
C-2120H	3	1	.875	.437	2 1/4	25/64	1 3/32	1 9/16	3 1/8	2 9/64	4 9/32	2 3/8	4 3/4	.219	1 1/8	3.56	.216	.432

† When ordering double pitch attachment chain specify either one hole or two holes in the attachment tab.

All sizes available in riveted construction. Size C2060 and above available in cottered construction. Please specify desired construction when ordering.

Conveyor series - large rollers bent attachments

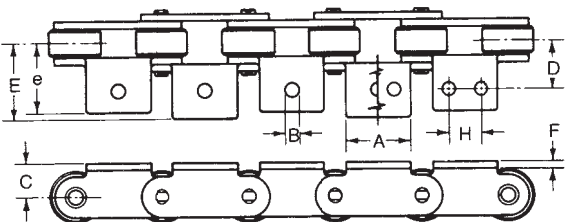

B-1

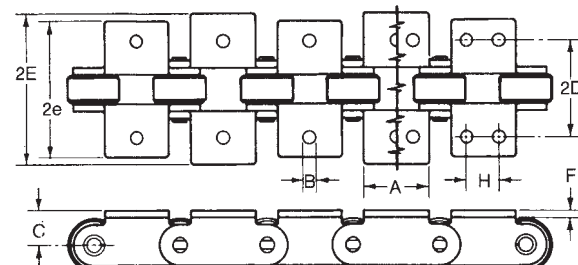

B-2

Chain No.	Pitch	Dimensions (Inches)													Weight In Lbs.			
		Roller		Pin Diam.	A	B+	C	D	2D	Over Roller Link		Over Pin Link		F	H	Chain Per Foot	Each Attach.	
		Width	Diam.							e	2e	E	2E				B-1	B-2
C-2042	1	5/16	.625	.156	3/4	9/64	23/64	1/2	1	11/16	1 3/8	49/64	1 17/32	.060	3/8	.58	.004	.008
C-2052	1 1/4	3/8	.750	.200	1	13/64	7/16	5/8	1 1/4	29/32	1 13/16	63/64	1 31/32	.080	15/32	.88	.014	.028
C-2062H	1 1/2	1/2	.875	.234	1 1/8	13/64	37/64	27/32	1 11/16	1 5/64	2 5/32	1 13/64	2 13/32	.125	9/16	1.48	.035	.070
C-2062H-T*	1 1/2	1/2	.875	.234	1 1/8	13/64	37/64	27/32	1 11/16	1 5/64	2 5/32	1 13/64	2 13/32	.125	9/16	1.00	.035	.070
C-2082H	2	5/8	1.125	.312	1 1/2	17/64	3/4	1 3/32	2 3/16	1 13/32	2 13/16	1 9/16	3 1/8	.156	3/4	2.40	.074	.148
C-2102H	2 1/2	3/4	1.562	.375	1 7/8	21/64	59/64	1 5/16	2 5/8	1 25/32	3 9/16	1 31/32	3 15/16	.187	15/16	4.56	.132	.264
C-2122H	3	1	1.750	.437	2 1/4	25/64	1 3/32	1 9/16	3 1/8	2 9/64	4 9/32	2 3/8	4 3/4	.219	1 1/8	5.56	.216	.432

† When ordering double pitch attachment chain specify either one hole or two holes in the attachment tab.

All sizes available in riveted construction. Size C2062 and above available in cottered construction. Please specify desired construction when ordering.

Conveyor series - standard rollers straight attachments

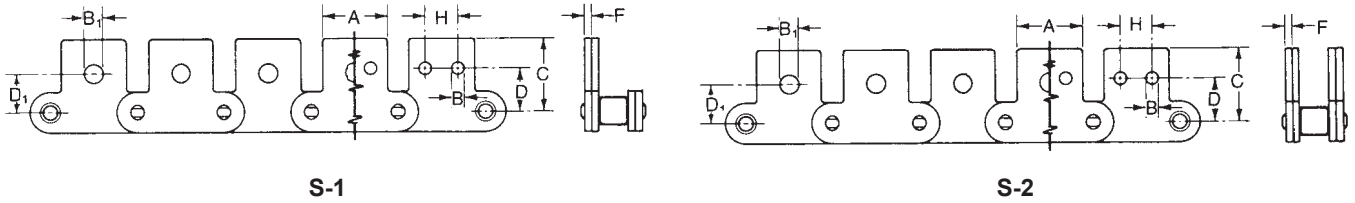

Chain No.	Pitch	Dimensions (Inches)											Weight In Lbs.		
		Roller		Pin Diam.	A	C	F	†With 1 Hole		†With 2 Holes			Chain Per Foot	Each Attach.	
		Width	Diam.					B ₁	D ₁	B	D	H		S-1	S-2
C-2040	1	5/16	.312	.156	3/4	25/32	.060	13/64	7/16	9/64	17/32	3/8	.34	.004	.008
C-2050	1 1/4	3/8	.400	.200	1	63/64	.080	17/64	9/16	13/64	5/8	15/32	.56	.014	.028
C-2060H	1 1/2	1/2	.468	.234	1 1/8	1 11/64	.125	21/64	11/16	13/64	3/4	9/16	1.01	.035	.070
C-2080H	2	5/8	.625	.312	1 1/2	1 37/64	.156	25/64	7/8	17/64	1	3/4	1.67	.074	.148
C-2100H	2 1/2	3/4	.750	.375	1 7/8	1 63/64	.187	33/64	1 1/8	21/64	1 1/4	15/16	2.47	.132	.264
C-2120H	3	1	.875	.437	2 1/4	2 11/32	.219	37/64	1 5/16	25/64	1 15/32	1 1/8	3.56	.216	.432

† When ordering double pitch attachment chain specify either one hole or two holes in the attachment tab.
All sizes available in riveted construction. Size C2060 and above available in cottered construction. Please specify desired construction when ordering.

Conveyor series - large rollers straight attachments

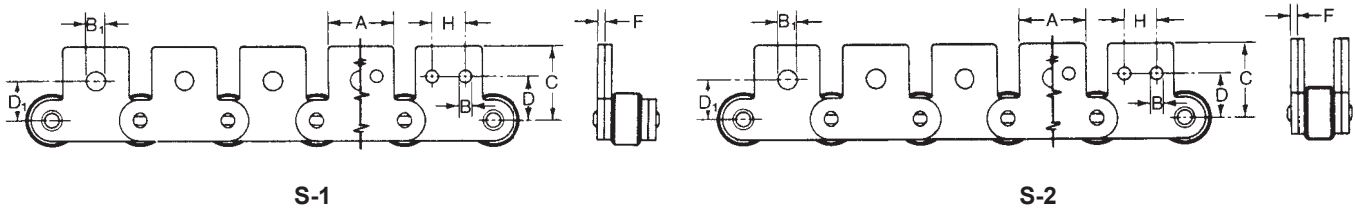

Chain No.	Pitch	Dimensions (Inches)											Weight In Lbs.		
		Roller		Pin Diam.	A	C	F	†With One Attach Hole		†With Two Attach Hole			Chain Per Foot	Each Attach.	
		Width	Diam.					B ₁	D ₁	B	D	H		S-1	S-2
C-2042	1	5/16	0.625	.156	3/4	25/32	.060	13/64	7/16	9/64	17/32	3/8	.58	.004	.008
C-2062H	1 1/4	3/8	0.750	.200	1	63/64	.080	17/64	9/16	13/64	5/8	15/32	.88	.014	.028
C-2082H	1 1/2	1/2	0.875	.234	1 1/8	1 11/64	.125	21/64	11/16	13/64	3/4	9/16	1.48	.035	.070
C-2062H-T*	1 1/2	1/2	0.875	.234	1 1/8	1 11/64	.125	21/64	11/16	13/64	3/4	9/16	1.00	.035	.070
C-2082H	2	5/8	1.125	.312	1 1/2	1 37/64	.156	25/64	7/8	17/64	1	3/4	2.40	.074	.148
C-2102H	2 1/2	3/4	1.562	.375	1 7/8	1 63/64	.187	33/64	1 1/8	21/64	1 1/4	15/16	4.56	.132	.264
C-2122H	3	1	1.750	.437	2 1/4	2 11/32	.219	37/64	1 5/16	25/64	1 15/32	1 1/8	5.56	.216	.432

† When ordering double pitch attachment chain specify either one hole or two holes in the attachment tab.
All sizes available in riveted construction. Size C2062 and above available in cottered construction. Please specify desired construction when ordering.

Conveyor series selection

Conveyor chain selection is usually based on the Working Load capacity of the chain rather than horsepower capacity. The allowable Working Loads are presented in the table below.

The following information provides the necessary formulas and factors needed to select the proper chain for a conveying application. The basic procedure is to determine the chain pull or working load, choose an appropriate chain size, and calculate the power required to operate the conveyor.

The Working Load or chain pull is calculated by using one of the following three formulas in conjunction with the coefficient of friction factors found in the tables.

For each of the following conveyor arrangements, there are formulas for the two most common conditions: the load supported by the chain and the load moved but not supported by the chain. The coefficient of friction for sliding material is found in the table.

Working loads for conveyor series chains

Chain No.	Pitch (in.)	Chain speed (ft/min)								
		5	25	50	75	100	200	300	400	500
C2040	1.00	530	525	510	490	465	335	230	160	115
C2050	1.25	870	865	840	805	765	555	380	265	190
C2060H	1.50	1215	1205	1170	1125	1065	775	530	370	265
C2080H	2.00	2070	2055	2000	1915	1815	1320	905	630	455
C2100H	2.50	3425	3400	3310	3175	3000	2180	1500	1040	750
C2120H	3.00	4855	4815	4690	4495	4250	3090	2125	1480	1065

Horizontal arrangement

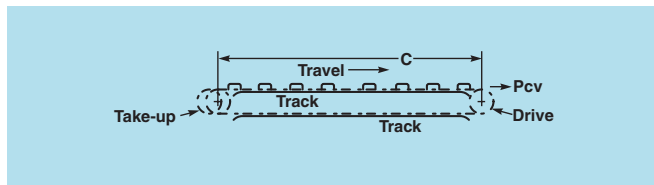

- a. Conveyed material moved but not supported by the chain:
 $P_a = C(2.1Mf + Wf_w) + J$
- b. Conveyed material is supported by chain. In this case, $f_w = f$ (of the chain—that is, f_s or f_r) and the formula becomes
 $P_b = Cf(2.1M + W) + J$
(J applies only when sidewalls are stationary)

The total conveyor pull is the sum of the following:

Pull on loaded run	$P = P_a$ or P_b
Pull on return run.....	$P_R = MCf$
Take-up pull*	P_{TU} or P_c
Pull to operate tail sprocket.....	$P_R \times .1$
Pull from other factors	P_o
Total conveyor pull	$\frac{P_o}{P_{cv}}$

Calculate the total chain pull per strand (P_T) by dividing P_{cv} by the number of strands taking the load.

Horsepower required to operate the conveyor

$$HP = \frac{(P_{cv} - P_{TU} \text{ or } P_c) \times 1.2 \times S}{33,000}$$

*Usually the takeup pull is known. If not, use 0.3% of the chain's ultimate strength as a reasonable estimate.

Inclined arrangement

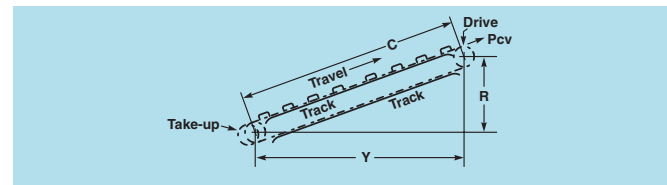

- a. Conveyed materials moved but not fully supported by the chain conveyor:
 $P_a = C(2Mf \cos \alpha + Wf_w \cos \alpha + W \sin \alpha) + J$
- b. Conveyed material is fully supported by the conveyor. In this case, $f_w = f$ and the formula becomes
 $P_b = Cf \cos \alpha (2M + W) + (CW \sin \alpha) + J$
 1. When Y and R are known:
 $\cos \alpha = \frac{Y}{C}$ and $\sin \alpha = \frac{R}{C}$
 2. When $(Mf \cos \alpha - Mf \sin \alpha)$ is a positive quantity, multiply the difference by 1.1 for tail shaft friction.

The total conveyor pull is the sum of the following:

Pull on loaded run	$P = P_a$ or P_b
Pull on return run**	$P_R = MYF$
Take-up pull*	P_{TU} or P_c
Pull to operate tail socket.....	$P_R \times .1$
Pull from other factors	P_o
Total conveyor pull	$\frac{P_o}{P_{cv}}$

Calculate the total chain pull per strand (P_T) by dividing P_{cv} by the number of strands taking the load.

Horsepower required to operate the conveyor

$$HP = \frac{(P_{cv} - P_{TU} \text{ or } P_c) \times 1.2 \times S}{33,000}$$

*Usually the takeup pull is known. If not, use 0.3% of the chain's ultimate strength as a reasonable estimate.

**Disregard when $\frac{R}{Y}$ is greater than factor f.

Vertical arrangement

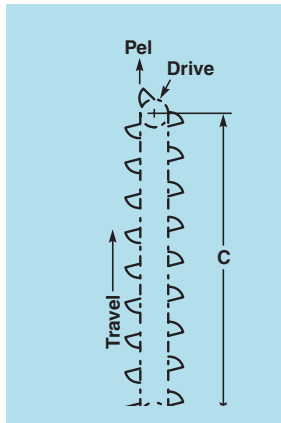

P = C(M + W)

The total elevator pull is the sum of the following:

- Pull on loaded run $P = (M+W) C$
- Take-up pull* P_{TU}
- Digging pull $P_B = x d$
- Pull to operate tail sprocket..... $P_{TU} \times .1$

Total elevator pull..... P_{EL}

Calculate the total chain pull per strand (P_T) by dividing P_{EL} by the number of chain strands used in the elevator

Horsepower required to operate the elevator.

$$HP = \frac{P_{EL} - (P_{TU} + MC) \times 1.2 \times S}{33,000}$$

*Usually the takeup pull is known. If not, use 0.3% of the chain's ultimate strength as a reasonable estimate.

For material with small lumps, multiple M by the sprocket diameter. For fine or fluffy materials, multiply M by the sprocket radius.

Friction factors f_r for double-pitch roller chains equipped with large rollers

Chain Number	Static*		Rolling	
	Dry	Lubricated	Dry	Lubricated
C-2042	0.17	0.12	0.14	0.10
C-2052	0.16	0.11	0.13	0.09
C-2062H	0.16	0.11	0.13	0.09
C-2082H	0.15	0.10	0.12	0.08
C-2102H	0.14	0.09	0.11	0.07
C-2122H	0.14	0.09	0.11	0.07

* Use static coefficient of friction for speeds of 3 ft/min or less.

Friction factors f_w for sliding of materials

Material	Coefficient
Coal on steel	0.33
Crushed stone or sand on steel	0.33
Cement on steel	0.80
Wood on Wood	0.55

Definitions

- M**, weight, in pounds per foot, of the moving elements of the conveyor as carried by the chains.
- W**, weight of material carried in pounds per foot of conveyor. (for unit materials, sum up the average weight of units expected to be on the conveyor at maximum capacity, and divide by the conveyor length in feet.)
- f**, coefficient of friction of chain, sliding or rolling (f_s or f_r), as given in the tables.
- f_w** , coefficient of friction of material sliding in trough, as given in the table or from other references. (Note: When material is entirely carried by conveyor, $f_w = f$.)
- J**, additional pull from drag of material on stationary sides of trough, given in the tables,
- S**, conveyor speed, in feet per minute.
- P**, conveyor pull, in pounds. (P_a or P_b).
- P_B** = Pull due to digging material from elevator boot, pounds
- P_C** = Centrifugal Pull = $\frac{\text{Chain Weight per Foot} \times (\text{FPM})^2}{115,900}$
- P_L** = Conveyor or elevator pull on loaded run, pounds
- P_O** = Conveyor pull from other sources, pounds
- P_R** = Conveyor pull on return run, pounds
- P_{CV}** = Total calculated conveyor pull, pounds
- P_{EL}** = Total calculated elevator pull, pounds
- P_{TU}** = Conveyor take-up pull, pounds
- HP** = Horsepower at head shaft
- C** = Length of conveyor in feet
- α** = Angle of conveyor incline (from horizontal)

Friction factors f_s for sliding roller conveyor chain

Condition	Dry	Lubricated
Static*	0.33	0.24
Sliding	0.27	0.21

* Use static coefficient of friction for speeds of 3 ft/min or less.

Trough drag friction factor J for materials

Material	R
Coal	14.0
Coke	35.0
Limestone	7.5
Gravel	7.0
Sand	5.5
Ashes	14.0

J = $\frac{Ch^2}{R}$ Where:
h = height of material in inches
R = variable factor for different material
C = length of conveyor in feet

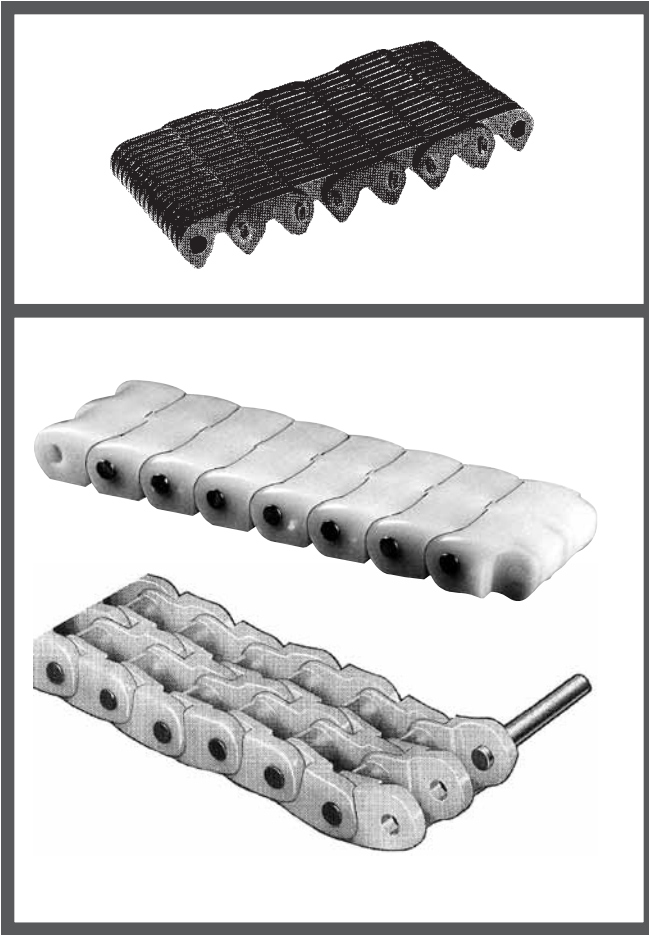

Silent chain

- Flat Top Surface
- Smooth Running
- High Speed Capacity
- High Temperature Tolerance
- Long Life
- Good Stability for Bottles, Cans, and Glassware

Delrin* chain

- Corrosion Resistant
- Runs On Standard Sprockets
- Low Friction
- Maintenance-Free
- Performs Without Lubrication
- Ambient Temperature Up to 180°F
- Stainless Steel Pin Available
- Compact Design
- Quieter Than Metal Chain

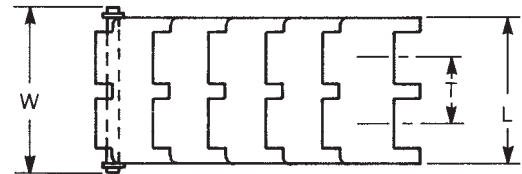
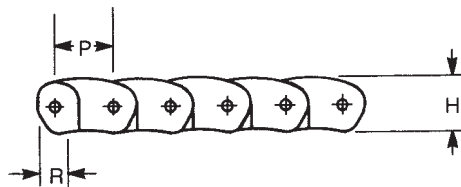
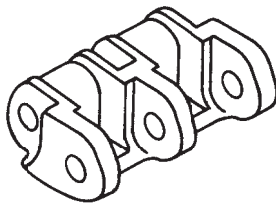

Chain No.	Dimensions (Inches)						Minimum Tensile Strength	Weight Per Foot
	P Pitch	R Roller Dia.	L Link Width	W Over Pin Width	H Height	T Transverse Pitch		
N400	1/2	.312	1.250	1.391	.484	.57	600	.37
N600	3/4	.464	1.938	2.031	.750	.85	1200	.69

Refer to pages G-39 and G-40, conveyor chain selection formulas for application design calculation. Use .25 coefficient of friction factor.

Chain is packaged in 10' or 50' lengths.

Pins are slip fit or drive fit in quantity of 10 per package. Specify choice when ordering. Standard pins are zinc plated. Stainless steel pins are available on a made-to-order basis.

Consult Technical Services for your application requirement.

©DuPont Registered Trademark

* Delrin is believed to be a trademark and/or trade name of E.I. Du Pont De Nemours and Company, and is not owned or controlled by Emerson Power Transmission.

Lift applications demand the frequent transmission of high lifting power at relatively low speeds. The constant flexure and frequent shock loads to which leaf chains are subjected, demand a tension linkage with maximum resistance to fatigue and wear. Morse® Leaf Chains are specifically designed to answer this need.

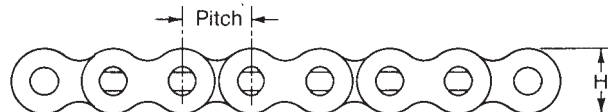
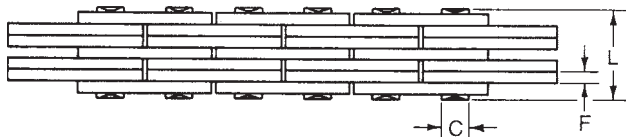

BL leaf chain

Dimensions (Inches)								
Leaf Chain No.	Pitch	Lacing	Pin Dia. (C)	Plate Thickness (F)	Plate Height (H)	Width Over Riveted Pins (L)	Approx. Weight Per Ft.	ANSI Minimum Ultimate Tensile Strength*
BL423	1/2"	2 X 3	.200	.080	.466	.495	.550	5,000
BL434		3 X 4				.660	.763	7,500
BL446		4 X 6				.910	1.082	10,000
BL523	5/8"	2 X 3	.234	.094	.584	.584	.797	7,500
BL534		3 X 4				.777	1.106	11,000
BL546		4 X 6				1.069	1.570	15,000
BL623	3/4"	2 X 3	.312	.125	.700	.786	1.197	11,000
BL634		3 X 4				1.048	1.657	17,000
BL644		4 X 4				1.179	1.888	22,000
BL646		4 X 6				1.441	2.348	22,000
BL666		6 X 6				1.705	2.809	33,000
BL822	1"	2 X 2	.375	.156	.934	.808	1.507	19,000
BL823		2 X 3				.970	1.940	19,000
BL834		3 X 4				1.294	2.682	29,000
BL844		4 X 4				1.455	3.068	38,000
BL846		4 X 6				1.781	3.820	38,000
BL866		6 X 6				2.105	4.573	57,000
BL1023	1 1/4"	2 X 3	.437	.187	1.166	1.152	3.005	26,000
BL1034		3 X 4				1.542	4.178	41,000
BL1044		4 X 4				1.733	4.764	52,000
BL1046		4 X 6				2.126	5.937	52,000
BL1066		6 X 6				2.511	7.111	78,000
BL1223	1 1/2"	2 X 3	.500	.219	1.400	1.352	4.080	34,000
BL1234		3 X 4				1.807	5.674	55,000
BL1244		4 X 4				2.033	6.472	68,000
BL1246		4 X 6				2.494	8.067	68,000
BL1266		6 X 6				2.947	9.662	102,000
BL1288		8 X 8				3.859	12.851	136,000
BL1423	1 3/4"	2 X 3	.562	.250	1.634	1.531	5.286	43,000
BL1434		3 X 4				2.048	7.356	71,000
BL1444		4 X 4				2.307	8.392	86,000
BL1446		4 X 6				2.825	10.462	86,000
BL1466		6 X 6				3.345	12.533	130,000
BL1623	2"	2 X 3	.687	.281	1.866	1.767	7.668	65,000
BL1634		3 X 4				2.360	10.663	99,000
BL1646		4 X 6				3.251	15.157	130,000
BL1688		8 X 8				5.035	24.146	260,000

- Plate Lacing construction
- Maximum lift strength per unit of width
- Larger pin diameters
- Heavier plate thickness
- Large Roller Link contour

Leaf Chain Lacing	
2 x 2	
2 x 3	
3 x 4	
4 x 4	
4 x 6	
6 x 6	
8 x 8	

* Minimum ultimate tensile strength is not the working load capacity of the chain. A service, or safety, factor must be applied, with regard to severity or application and experience of user, when designing application.
NOTE: Replacement chain specifications should be verified by lift manufacturer.

Standard lengths... 10 ft

AL (light) series of leaf chains is no longer standard and has been deleted by ANSI and ISO (International Standards Organization). Morse can furnish as replacement (new applications should use BL series) on a made-to-order basis subject to suitable quantities.

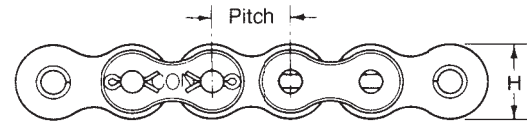
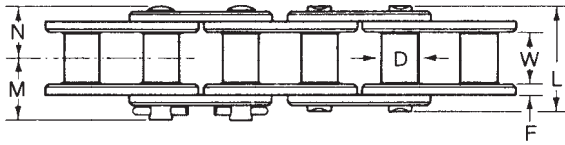

Rollerless hoist chain

Catalog No.	Dimensions (Inches)									ANSI Minimum Ultimate Tensile Strength*	Approx. Weight Per Foot
	Pitch	W Bushing Width	D Bushing Dia.	C-Pin Dia.	F-Plate Thickness	L-Width Over Pins	H-Inside Plate Height	N	M		
65	3/4	1/2	.344	.234	.094	.990	.700	.495	.586	7000	.82
85	1	5/8	.460	.312	.125	1.274	.934	.637	.741	12500	1.46
8-85	1	5/8	.460	.312	.125	1.274	.934	.637	.741	14700	1.46
105	1 1/4	3/4	.554	.375	.156	1.555	1.166	.778	.923	19500	2.17

* Minimum ultimate tensile strength is not the working load capacity of the chain.

A service, or safety, factor must be applied, with regard to severity or application and experience of user, when designing an application.

Available in Riveted and Cotted construction. Please specify desired construction when ordering.

CAUTION- Avoid use in known corrosive atmospheres. Consult Technical Services when in doubt.

NOTE- Replacement chain specifications should be verified by lift manufacturer, some manufacturers utilize chains with special tensile ratings.

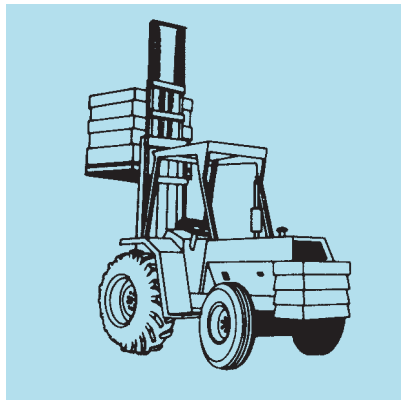

LIFT TRUCK

Use only drive fit connectors in lifting applications



Standard lengths...10 ft

Morse® Rollerless hoist chains are made of the same high quality and fatigue resistant parts as standard Morse Roller Chains—only the rollers have been omitted. This allows a saving to the user without a sacrifice of capacity.

Rollerless hoist chains are used on applications where speeds are slow and joint articulation is infrequent. Typical application—as the lifting device on fork lift trucks. Chain is used with sheaves or rollers instead of sprockets.

Chains on this page should not be used for sprocket Hoist applications. Consult Technical Services for Hoist application recommendations.

Broad Product Offering • Highest Quality

No other company offers all these features and benefits in reliable chain drives. Select from a full range of pre-stressed roller chain: standard and heavy series, single and multiple strand; custom conveyor chain with a variety of attachments; specialty chain; HV inverted tooth and SC silent chain; leaf chain, plus many more specialized designs.

ASME/ANSI Chain Products

Single Strand	Pitch
Standard Series.....	25 - 200
Heavy Series.....	60 - 200
High Strength.....	60 - 200
Lubed For Life.....	40 - 80
Standard Attachment.....	25 - 160
Double Pitch Conveyor	
Standard Roller.....	2040 - 2120
Large Roller.....	2042 - 2122
Double Pitch Attachment.....	C2040 - C2122
Other	
Leaf.....	BL4 - BL16
Rollerless Hoist.....	60 - 100
Wrench.....	50
Agricultural.....	80
Moisture Guard.....	35 - 80
HV Inverted Tooth Chain.....	3/8 - 2
SC Silent Chain.....	3/16 - 1
Stainless Steel.....	25 - 80
Nickel Plated.....	35 - 60
Pre-Lubricated.....	40 - 80
Multi Flex	100 - 200
Multiple Strand	
Standard	
Double, Triple, Quadruple.....	35 - 200
Quintuple, Sextuple, Octuple.....	60 - 160
Heavy	
Double, Triple, Quadruple.....	60 - 200
Quintuple, Sextuple.....	60 - 160
Pre-Lubricated Double	40 - 50

Precision round bushings improve surface control — less wear, longer life.

Shot peened solid rollers of optimal wall thickness, finer finish, more impact strength.

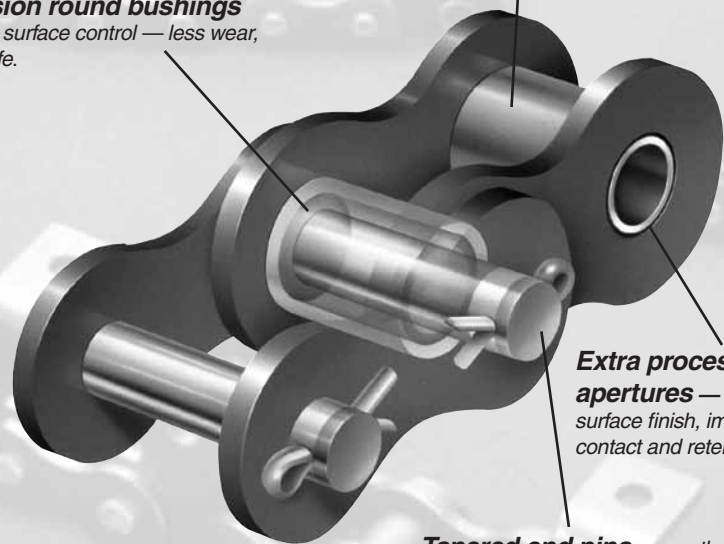

Extra processing of link apertures — fatigue resistant surface finish, improved pin contact and retention.

Tapered end pins - smooth trouble-free assembly, helps prevent link-plate damage.



Morse® attachment chain is offered in a significant breadth of line — 35 to 160, C2040 to C2122, with excellent custom design capabilities.



HV Chain



Leaf Chain

Corrosion resistant materials available for all styles!

Morse provides a wide range of high quality roller chain solutions to meet application needs for many different industries. With 100 years of experience in chain products that meet or exceed industry standard; Morse delivers exceptional customer value.

Morse offers several corrosion resistant roller chain solutions to help customers with challenging applications in harsh environments.



Chain Types

Morse provides corrosion resistant materials for most chain styles.

Moisture Guard® Chain

- Corrosion protection with high strength and wear resistance
- Plated before assembly for through corrosion protection
- Custom Moisture Guard chain available for design according to your application needs for materials, platings, coatings and lubricants
- Stocked in 35 through 80 pitch in 10 ft. packages or cut-to-length

How to Order:

Simply add an MG after the pitch size. For example, order 60MG R for 60 pitch riveted Moisture Guard Chain.

"New" Enhanced Moisture Guard® Chain

- Especially tough applications
- Each chain designed to your specific need
- Let us design your chain requirements for corrosion protection with high strength and wear resistance

Nickel Plated Roller Chain

- High quality nickel plating applied to chain parts prior to assembly
- Outstanding appearance and corrosion resistance
- Many sizes available from stock, with or without attachments – other sizes and special attachments available upon request

Stainless Steel Roller Chain

- 300 Series stainless steel for the most corrosive environments
- Stocked in 25 through 120, including popular attachments – other sizes and special attachments also available

Corrosion Resistant Attachment Chain

- Available in standard carbon steel, nickel plated, Moisture Guard, stainless steel and custom designs on a made-to-order basis

For customized chain solutions, contact Application Engineering at 1-800-626-2093 or by email at applicationengineering@emerson-ept.com to solve your chain corrosion problems

ASTMB-117 • 500 Hour Salt Spray Test



Competitor "Water Proof" Chain



Morse® Moisture Guard® Chain

Stainless steel roller chain

Morse® standard stainless steel chain utilizes 18-8 chromium nickel (300 Series) steel. These chains can be used in the most corrosive environments. These include high moisture, hot operations found in many food handling and packaging applications. The 300 Series chain provides maximum corrosion resistance to other harsh conditions such as operations using acids and alkalis at elevated temperatures.

Morse standard stainless steel chain is a preferred choice where cleanliness of operation is either desired or required. In applications where wear life is the prime concern, we offer on a made-to-order basis stainless steel chain utilizing 300 Series side plates and heat treated 400 Series pins, rollers, and bushings. This combination provides the most durable balance to corrosion and wear resistance.

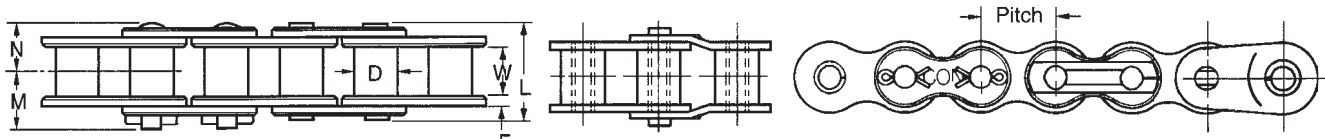

Stainless steel roller chain-single strand

Catalog No.	Dimensions (Inches)										
	Pitch	W-Roller Width	D-Roller Dia.	C-Pin Dia.	F-Plate Thk	L-Width Over Pins	H-Inside Plate Height	N	M	Average Tensile Strength	Weight Per Foot
*25-SS	1/4	1/8	.130	.091	.030	.312	.230	.150	.190	700	.09
*35-SS	3/8	3/16	.200	.141	.050	.466	.350	.233	.267	1,700	.22
40-SS	1/2	5/16	.312	.156	.060	.630	.466	.315	.380	2,700	.43
41-SS	1/2	1/4	.306	.141	.050	.512	.390	.260	.370	1,950	.28
50-SS	5/8	3/8	.400	.200	.080	.790	.584	.395	.460	4,700	.71
60-SS	3/4	1/2	.468	.234	.094	.990	.700	.495	.586	6,750	1.03
80-SS	1	5/8	.625	.312	.125	1.274	.908	.643	.762	11,500	1.60

* Rollerless

Standard attachments and other sizes of chains are available on made-to-order basis.

All sizes available in Riveted construction only.

Nickel plated roller chain

Morse® nickel plated chain may be desirable in mildly corrosive areas. The appearance is a nickel gloss resembling the satin finish of stainless steel.

The chain is carefully processed to ensure the highest quality. Parts are plated prior to assembly to assure all critical areas are protected. Tensile strength meets A.N.S.I. specifications.

Do not attempt to plate stock assembled carbon steel chain - side plates can fracture.

Nickel plated roller chain-single strand

Chain No.	Dimensions (Inches)										
	Pitch	W-Roller Width	D-Roller Dia.	C-Pin Dia.	F-Plate Thickness	L-Width Over Pins	H-Inside Plate Height	N	M	Average Tensile Strength	Weight Per Foot
*35N	3/8	3/16	.200	.141	.050	.466	.350	.233	.267	2,100	.21
40N	1/2	5/16	.312	.156	.060	.630	.466	.315	.380	3,700	.42
50N	5/8	3/8	.400	.200	.080	.790	.584	.395	.460	6,100	.69
60N	3/4	1/2	.468	.234	.094	.990	.700	.495	.586	8,500	1.00

* Rollerless

Standard attachments and other sizes of chains are available on made-to-order basis.

All sizes available in Riveted construction only.

Chains on this page should not be used for Hoisting applications. Consult Technical Services for Hoist application recommendations.

LL CHAIN - longer chain life with minimum lubrication maintenance

Morse® Sintered Bushing Chain combines the precision workmanship and quality construction of Morse ANSI roller chain with the self-lubricating properties of oil impregnated, sintered metal bushings to assure longer, more reliable chain service where external lubrication is prohibited or severely limited.

A reservoir of oil is locked into the controlled porosity of the sintered metal bushings. Chain movement releases this oil to all bearing surfaces of bushings, pins, plates and sprocket teeth minimizing wear and power loss. When the chain comes to rest, the lubricant is reabsorbed into the bushings for future use.

Self lubrication is clean and effective

Morse® LL Chain is specifically engineered to give maximum chain life in power transmission and conveying applications where:

1. External lubrication is impossible, impractical, or frequently neglected.
2. External lubrication is not permitted for sanitation or contamination reasons.

Morse LL Chain is:

- Available from stock in 4 standard pitches-1/2", 5/8", 3/4", and 1".
- Dimensionally interchangeable with ANSI roller chain of the same size; operates on the same sprockets.
- Pre-stressed for better pitch control and increased fatigue resistance.
- Packaged for "off-the-shelf" availability.

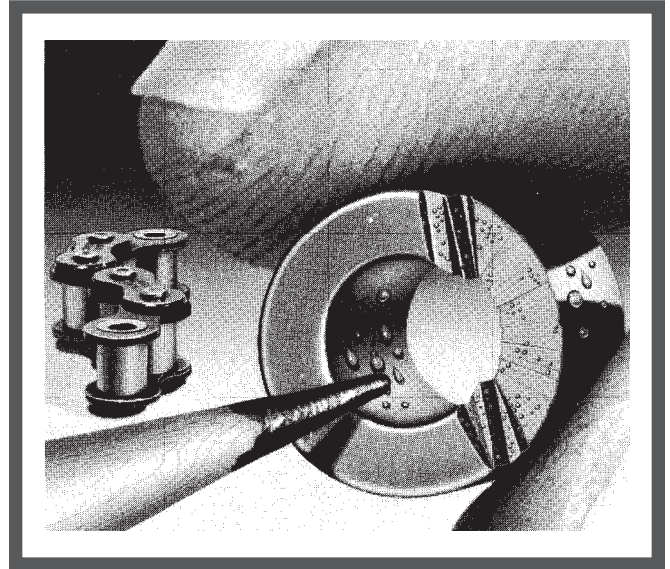

Periodic addition of external lubrication—when possible extends the service life of Morse LL Chain. Where adequate external lubrication can be provided, Morse standard roller chain with its higher horsepower capacity and superior fatigue strength is recommended for best chain performance. If Morse LL Chain is to be used in temperatures over 125°F or under prolonged exposure to solvents or detergents, consult Morse for recommendations. Optimum speed range for Morse LL Chain is up to 600 feet per minute.

Applications

- Food processing and handling
- Packaging machinery
- Farm equipment such as blowers, dryers, and feeders
- Textile industry
- Paper and printing machinery
- Vending machines
- Chemical operations and processing
- Construction machinery
- Material handling equipment
- Mobile or portable vehicles

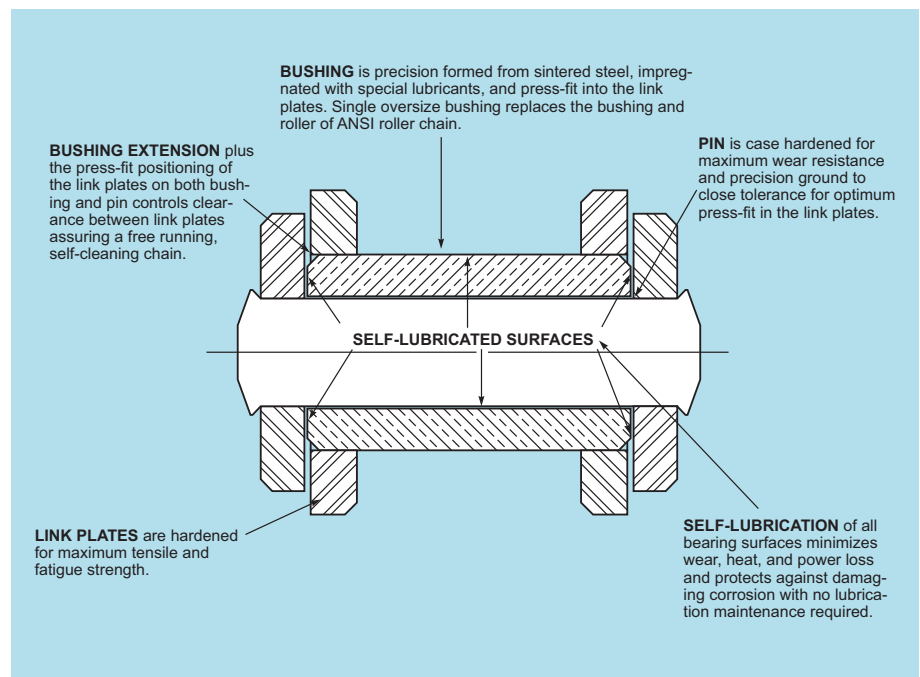

Solve problems of hit or miss lubrication maintenance or product contamination with **MORSE Sintered Bushing** chain.

Standard series-single strand

Catalog No.	Dimensions (Inches)									Average Tensile Strength	Weight Per Foot
	Pitch	W-Roller Width	D-Roller Dia.	C-Pin Dia.	F-Plate Thickness	L-Width Over Pins	H-Inside Plate Height	N	M		
40LL	1/2	5/16	.312	.156	.060	.630	.466	.315	.380	3400	.42
50LL	5/8	3/8	.400	.200	.080	.790	.584	.395	.460	5500	.69
60LL	3/4	1/2	.468	.234	.094	.990	.700	.495	.586	7500	1.00
80LL	1	5/8	.625	.312	.125	1.274	.934	.637	.741	13000	1.71

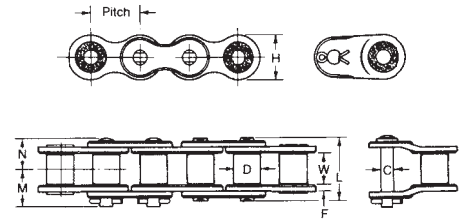

Horsepower ratings

No. of Teeth Small Sprkt.	40 LL - 1/2" Pitch Sintered Bushing Chain											
	Revolutions Per Minute - Small Sprocket											
	50	100	200	300	400	500	600	700	800	900	1000	1200
11	0.21	0.38	0.69	0.96	1.19	1.41	1.59	1.75	1.89	2.02	2.14	2.32
12	0.22	0.42	0.77	1.07	1.34	1.58	1.81	2.00	2.16	2.81	2.46	2.71
13	0.24	0.46	0.84	1.18	1.48	1.76	2.00	2.24	2.44	4.62	2.79	
14	0.26	0.50	0.91	1.28	1.63	1.93	2.20	2.46	2.67	2.88	3.09	
15	0.28	0.54	0.99	1.39	1.76	2.09	2.40	2.67	2.93	3.16		
16	0.30	0.57	1.06	1.49	1.89	2.25	2.59	2.89	3.17	3.43		
17	0.32	0.61	1.13	1.59	2.02	2.41	2.77	3.10	3.41			
18	0.34	0.65	1.20	1.70	2.15	2.57	2.94	3.31	3.63			
19	0.36	0.69	1.27	1.80	2.28	2.72	3.14	3.51				
20	0.38	0.72	1.34	1.90	2.40	2.87	3.29	3.70				
21	0.40	0.76	1.41	1.99	2.52	3.01	3.47					
22	0.42	0.79	1.48	2.08	2.64	3.15	3.63					
23	0.44	0.83	1.54	2.18	2.76	3.30	3.79					
24	0.46	0.87	1.60	2.27	2.88	3.44	3.96					
25	0.48	0.90	1.67	2.36	3.00	3.58						
30	0.57	1.08	1.99	2.81	3.56							
35	0.66	1.25	2.30	3.24	4.09							
40	0.75	1.41	2.60	3.65								
45	0.84	1.58	2.89	4.04								
50	0.93	1.74	3.17									
55	1.01	1.89	3.44									
60	1.10	2.05	3.71									

Use Standard ANSI Roller Chain

No. of Teeth Small Sprkt.	50 LL - 5/8" Pitch Sintered Bushing Chain											
	Revolutions Per Minute - Small Sprocket											
	50	100	200	300	400	500	600	700	800	900	1000	
11	0.39	0.72	1.29	1.78	2.19	2.56	2.85	3.12	3.33	3.53	3.68	
12	0.43	0.80	1.44	1.99	2.48	2.90	3.26	3.58	3.86	4.10		
13	0.47	0.87	1.59	2.20	2.74	3.23	3.65	4.03	4.36			
14	0.51	0.91	1.73	2.41	3.01	3.55	4.02	4.45	4.84			
15	0.54	1.02	1.87	2.61	3.27	3.86	4.39	4.88				
16	0.58	1.09	2.00	2.81	3.52	4.16	4.74	5.26				
17	0.62	1.16	2.14	2.99	3.77	4.46	5.09					
18	0.66	1.23	2.27	3.19	4.01	4.75	5.41					
19	0.70	1.31	2.41	3.39	4.25	5.05	5.76					
20	0.73	1.38	2.54	3.56	4.48	5.22						
21	0.77	1.45	2.66	3.75	4.70	5.59						
22	0.81	1.52	2.79	3.92	4.92	5.86						
23	0.84	1.58	2.91	4.09	5.16	6.12						
24	0.88	1.65	3.05	4.27	5.37							
25	0.91	1.72	3.17	4.45	5.59							
30	1.09	2.06	3.77	5.28								
35	1.27	2.38	4.35	6.07								
40	1.44	2.70	4.91									
45	1.61	3.01	5.44									
50	1.78	3.31	5.86									
55	1.94	3.60	6.47									
60	1.96	3.90										

Use Standard ANSI Roller Chain

No. of Teeth Small Sprkt.	60 LL - 3/4" Pitch Sintered Bushing Chain									
	Revolutions Per Minute - Small Sprocket									
	50	100	150	200	300	400	500	600	700	800
11	0.66	1.21	1.70	2.15	2.93	3.58	4.12	4.56	4.93	5.21
12	0.73	1.34	1.90	2.41	3.30	4.05	4.70	5.24	5.71	6.08
13	0.79	1.48	2.09	2.65	3.65	4.52	5.27	5.91	6.46	
14	0.86	1.60	2.27	2.90	4.00	4.97	5.79	6.54		
15	0.92	1.72	2.45	3.14	4.34	5.39	6.32	7.14		
16	0.99	1.85	2.64	3.36	4.66	5.82	6.82	7.73		
17	1.05	1.97	2.82	3.59	4.98	6.22	7.32			
18	1.12	2.10	2.99	3.82	5.31	6.63	7.82			
19	1.18	2.23	3.17	4.05	5.62	7.03	8.29			
20	1.25	2.34	3.34	4.26	5.93	7.41				
21	1.31	2.46	3.51	4.49	6.24	7.80				
22	1.37	2.58	3.67	4.70	6.54	8.16				
23	1.44	2.69	3.83	4.90	6.83	8.53				
24	1.50	2.80	4.00	5.11	7.12	8.90				
25	1.56	2.92	4.17	5.32	7.41					
30	1.86	3.48	4.96	6.32	8.78					
35	2.16	4.03	5.73	7.29						
40	2.45	4.55	6.46	8.20						
45	2.73	5.07	7.18	9.10						
50	3.02	5.59	7.87							
55	3.29	6.07	8.54							
60	3.58	6.55	9.21							

Use Standard ANSI Roller Chain

No. of Teeth Small Sprkt.	80 LL - 1" Pitch Sintered Bushing Chain												
	Revolutions Per Minute - Small Sprocket												
	25	50	100	150	200	250	300	350	400	450	500	550	600
11	0.81	1.52	2.76	3.83	4.78	5.62	6.36	7.02	7.60	8.12	8.56	8.89	0
12	0.89	1.68	3.08	4.28	5.36	6.33	7.20	7.97	8.67	9.28	9.84	10.3	10.7
13	0.97	1.83	3.36	4.72	5.93	7.03	8.03	8.93	9.75	10.5	11.2	11.8	
14	1.05	1.99	3.66	5.15	6.49	7.71	8.82	9.84	10.8	11.6	12.39		
15	1.13	2.14	3.95	5.57	7.03	8.37	9.59	10.7	11.8	12.7			
16	1.21	2.30	4.24	5.98	7.56	9.01	10.3	12.7	13.7				
17	1.29	2.44	4.52	6.39	8.09	9.65	11.08	12.04	13.6				
18	1.37	2.59	4.80	6.79	8.60	10.3	11.8	13.2	14.5				
19	1.45	2.75	5.09	7.20	9.13	10.9	12.53	14.04					
20	1.52	2.87	5.36	7.57	9.60	11.5	13.2	14.8					
21	1.60	3.03	5.62	7.96	10.1	12.1	13.9						
22	1.67	3.18	5.90	8.34	10.6	12.6	14.5						
23	1.75	3.32	6.16	8.75	11.1	13.2	15.2						
24	1.83	3.46	6.43	9.09	11.5	13.8	15.8						
25	1.90	3.61	6.69	9.45	12.0	14.3							
30	2.27	4.31	7.96	11.2	14.2								
35	2.64	4.99	9.29	13.0	16.4								
40	3.00	5.65	10.4	14.6									
45	3.35	6.31	11.6	16.2									
50	3.70	6.95	12.7										
55	4.05	7.58	13.8										
60	4.39	8.20	15.0										

Use Standard ANSI Roller Chain

High strength chain

Morse® High strength Roller Chains are designed to meet the instantaneous peak loading requirements of applications such as rugged construction equipment. The design features through hardened pins and is available in HEAVY SERIES USING HEAVY SIDE PLATES.

Only the finest high quality steels are selected, then through-hardened with a special temper draw process to give optimum strength. Manufacturing features which are characteristic of all Morse Chains are employed ... carbon restoration, shot peening, ballizing ... all the processes required to insure unparalleled fatigue resistant chains.

Most applications are capably handled with Morse standard (carburized pins) chains which have high fatigue strength and premium roller impact and wear life. For applications where heavy shock loads or impacts are encountered, use the Morse High Strength series chains made with through-hardened alloy steel pins.

While through-hardened pins have somewhat reduced wear properties when compared to Morse standard carburized pins, careful control of the heat treating process holds this wear resistant loss to a minimum.

Morse High Strength Chains are made to A.N.S.I. dimensional specifications, and will operate on standard chain sprockets.

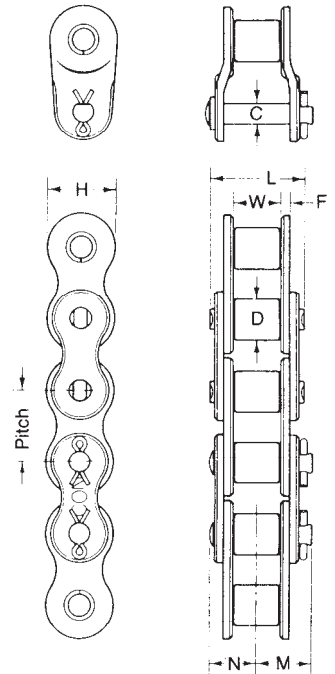

Catalog No.	Dimensions (Inches)										Average Tensile Strength	Weight Per Foot
	Pitch	W-Roller Width	D-Roller Dia.	C-Pin Dia.	F-Plate Thickness	L-Width Over Pins	H-Inside Plate Height	N	M			
8-60-H	3/4	1/2	.468	.234	.125	1.115	.700	.558	.627	10,000	1.22	
8-80-H	1	5/8	.625	.312	.156	1.400	.934	.700	.804	21,000	2.03	
8-100-H	1 1/4	3/4	.750	.375	.187	1.684	1.166	.842	.986	30,000	3.00	
8-120-H	1 1/2	1	.875	.437	.219	2.090	1.400	1.045	1.214	42,000	4.30	
8-140-H	1 3/4	1	1.000	.500	.250	2.241	1.634	1.121	1.276	56,000	5.50	
8-160-H	2	1 1/4	1.125	.562	.281	2.646	1.866	1.323	1.513	70,000	7.20	
8-200-H	2 1/2	1 1/2	1.562	.781	.375	3.374	2.334	1.687	1.904	110,000	12.30	

Available in Riveted and cottered construction. Please specify desired construction when ordering.

Wrench chain

Morse® Wrench Chain is made with the same precision that goes into Morse Roller and Leaf Chains, therefore Morse Wrench Chain will give the same high precision tolerances and high physical standards associated with other Morse chains.

The two center plates have a slip fit, to assure smooth articulation, while the outside plates have an interference fit. The high strength extended pins are to engage the clevis member, or jaw, of the wrench chain tool.

Morse wrench chain

No. WC-522

A.N.S.I. roller chain pin link plates and pins average ultimate strength: 7,400 lbs

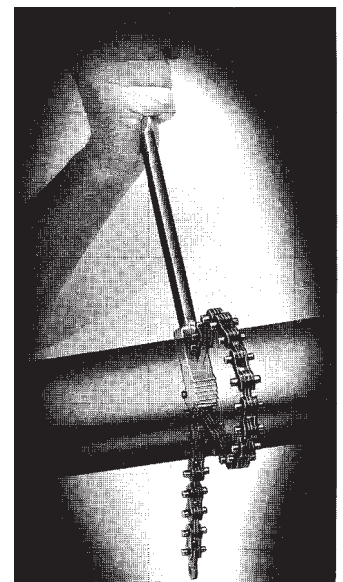
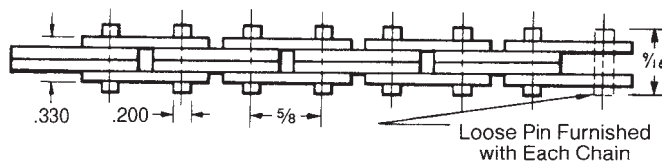

Sticker chain

#80 sticker chain is made of the same high quality chain parts as regular chain. Chain is used extensively as a "gathering" chain in sugar cane harvesters. It has found wide acceptance in the lumber industry as a "tree debarker" when used in multiple strand widths.

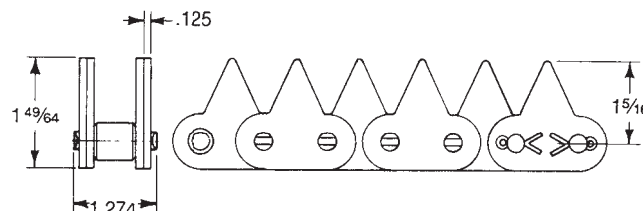

Chains on this page should not be used for Hoisting applications. Consult Technical Services for Hoist application recommendations.

The many quality control features in Browning ANSI B29.1 roller chain are your best insurance against excessive drive costs and high maintenance. Browning® chain is manufactured to rigid specifications, using some of the industry's most modern equipment and methods. Insist on Browning dependability when you buy roller chain... it will save you both time and money.

① ALL BROWNING ANSI B29.1 ROLLER CHAIN IS PRE-STRESSED, a production operation that permanently "seats" the various chain components. Prestressing minimizes the chain stretch which often occurs with ordinary chain during the initial running period, thus avoids excessive early wear and reduces the need for take-up adjustment. Prestressing minimizes tolerance variations, too, ensuring balanced loading among all parts and avoiding premature fatigue failure.

② SHOT PEENING also increases resistance to fatigue. In the shot peening process, Browning chain parts are bombarded by tiny pellets to set up residual stresses that increase the fatigue strength of the Chain.

③ CASE HARDENING of pins and bushings means longer life for Browning chain. Pins are centerless ground to finish diameter.

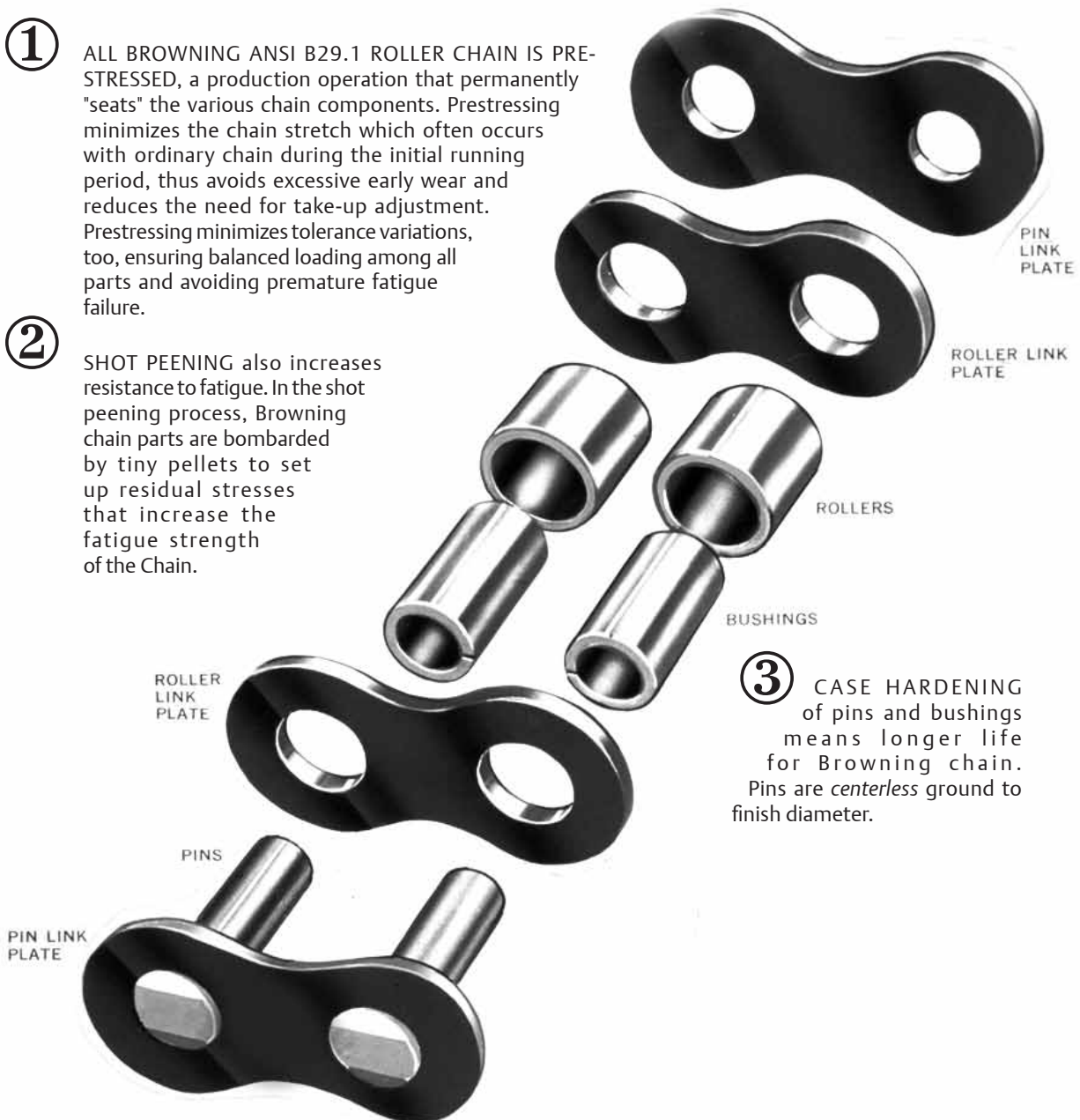

Table No.1

Stock Single and Multiple Strand Chain and Parts

Part Number	CHAIN			PARTS ●		
	Pitch	Feet per Package ▲	Wt-Lbs. per Package	Spring Clip Connecting Links	Cotter Pin Connecting Links	Offset Links
SINGLE STRAND ROLLER CHAIN						
J35 RIV 10 FT CH	3/8"	10(2)	2.3	J35 S/C C/L (25)	—	J35 O/S C/L (25)
J35 RIV 250 FT CH	3/8	250(50)	57.5	J35 S/C C/L (25)	—	J35 O/S C/L (25)
J41 RIV 10 FT CH	1/2	10(2)	2.8	J41 S/C C/L (25)	—	J41 O/S C/L (25)
J41 RIV 250 FT CH	1/2	250(50)	70.0	J41 S/C C/L (25)	—	J41 O/S C/L (26)
J40 RIV 10 FT CH	1/2	10(2)	4.1	J40 S/C C/L (25)	—	J40 O/S C/L (25)
J40 RIV 200 FT CH	1/2	200(40)	82.0	J40 S/C C/L (25)	—	J40 O/S C/L (25)
J50 RIV 10 FT CH	5/8	10(2)	6.9	J50 S/C C/L (25)	—	J50 O/S C/L (25)
J50 RIV 100 FT CH	5/8	100(20)	69.0	J50 S/C C/L (25)	—	J50 O/S C/L (25)
J60 RIV 10 FT CH	3/4	10(2)	10.4	J60 S/C C/L (25)	J60 C/P C/L (25)	J60 O/S C/L (25)
J60 RIV 100 FT CH	3/4	100(20)	104.0	J60 S/C C/L (25)	J60 C/P C/L (25)	J60 O/S C/L (25)
J80 RIV 10 FT CH	1	10(1)	17.7	—	J80 C/P C/L (10)	J80 O/S C/L (10)
J80 RIV 50 FT CH	1	50(5)	88.5	—	J80 C/P C/L (10)	J80 O/S C/L (10)
J80 CP 10 FT CH	1	10(1)	17.7	—	J80 C/P C/L (10)	J80 O/S C/L (10)
J100 RIV 10 FT CH	1 1/4	10(1)	25.9	—	J100 C/P C/L (10)	J100 O/S C/L (10)
J100 RIV 50 FT CH	1 1/4	50(5)	129.5	—	J100 C/P C/L (10)	J100 O/S C/L (10)
J100 CP 10 FT CH	1 1/4	10(1)	25.9	—	J100 C/P C/L (10)	J100 O/S C/L (10)
J120 RIV 10 FT CH	1 1/2	10(1)	40.5	—	J120 C/P C/L (5)	J120 O/S C/L (5)
J120 RIV 50 FT CH	1 1/2	50(5)	202.5	—	J120 C/P C/L (5)	J120 O/S C/L (5)
J120 CP 10 FT CH	1 1/2	10(1)	40.5	—	J120 C/P C/L (5)	J120 O/S C/L (5)
J140 RIV 10/2 FT CH	1 3/4	10.2(1)	52.1	—	J140 C/P C/L (5)	J140 O/S C/L (5)
J140 CP 10/2 FT CH	1 3/4	10.2(1)	52.1	—	J140 C/P C/L (5)	J140 O/S C/L (5)
J160 RIV 10 FT CH	2	10(1)	68.5	—	J160 C/P C/L (2)	J160 O/S C/L (2)
J160 CP 10 FT CH	2	10(1)	68.5	—	J160 C/P C/L (2)	J160 O/S C/L (2)
DOUBLE STRAND ROLLER CHAIN						
J35-2 RIV 10 FT CH	3/8	10(2)	4.6	J35-2 S/C C/L (25)	—	J35-2 O/S C/L (25)
J40-2 RIV 10 FT CH	1/2	10(2)	8.2	J40-2 S/C C/L (25)	—	J40-2 O/S C/L (25)
J50-2 RIV 10 FT CH	5/8	10(2)	13.8	J50-2 S/C C/L (25)	—	J50-2 O/S C/L (25)
J60-2 RIV 10 FT CH	3/4	10(2)	20.8	J60-2 S/C C/L (25)	J60-2 C/P C/L (25)	J60-2 O/S C/L (25)
J60-2 CP 10 FT CH	3/4	10(2)	20.8	J60-2 S/C C/L (25)	J60-2 C/P C/L (25)	J60-2 O/S C/L (25)
J80-2 RIV 10 FT CH	1	10(1)	35.4	—	J80-2 C/P C/L (10)	J80-2 O/S C/L (10)
J80-2 CP 10 FT CH	1	10(1)	35.4	—	J80-2 C/P C/L (10)	J80-2 O/S C/L (10)
J100-2 RIV 10 FT CH	1 1/4	10(1)	51.8	—	J100-2 C/P C/L (5)	J100-2 O/S C/L (5)
J100-2 CP 10 FT CH	1 1/4	10(1)	51.8	—	J100-2 C/P C/L (5)	J100-2 O/S C/L (5)
J120-2 RIV 10 FT CH	1 1/2	10(1)	81.0	—	J120-2 C/P C/L (2)	J120-2 O/S C/L (2)
J120-2 CP 10 FT CH	1 1/2	10(1)	81.0	—	J120-2 C/P C/L (2)	J120-2 O/S C/L (2)
J140-2 CP 10/2 FT CH	1 3/4	10.2(1)	104.1	—	J140-2 C/P C/L (2)	J140-2 O/S C/L (2)
J160-2 CP 10 FT CH	2	10(1)	137.0	—	J160-2 C/P C/L (1)	J160-2 O/S C/L (1)
TRIPLE STRAND ROLLER CHAIN						
J35-3 RIV 10 FT CH	3/8	10(2)	6.9	J35-3 S/C C/L (25)	—	J35-3 O/S C/L (25)
J40-3 RIV 10 FT CH	1/2	10(2)	12.3	J40-3 S/C C/L (25)	—	J40-3 O/S C/L (25)
J50-3 RIV 10 FT CH	5/8	10(2)	20.7	J50-3 S/C C/L (25)	—	J50-3 O/S C/L (25)
J60-3 RIV 10 FT CH	3/4	10(2)	31.2	J60-3 S/C C/L (25)	J60-3 C/P C/L (15)	J60-3 O/S C/L (15)
J60-3 CP 10 FT CH	3/4	10(2)	31.2	J60-3 S/C C/L (25)	J60-3 C/P C/L (15)	J60-3 O/S C/L (15)
J80-3 RIV 10 FT CH	1	10(1)	53.1	—	J80-3 C/P C/L (10)	J80-3 O/S C/L (5)
J80-3 CP 10 FT CH	1	10(1)	53.1	—	J80-3 C/P C/L (10)	J80-3 O/S C/L (5)
				—		
				—		
				—		
				—		

▲ Number of Connecting Links in a Standard Package of Chain is shown in parenthesis.

● Number of Parts per Standard Package shown in Parenthesis.

1. Prestressed to firmly seat chain parts, evenly distribute the working load, establish accurate length and reduce elongation during initial break-in.
2. Meets or exceeds A.N.S.I. horsepower rating requirements. Ratings shown on Pages G58 to G62 apply.



Single Strand—Riveted



Single Strand—Cottered

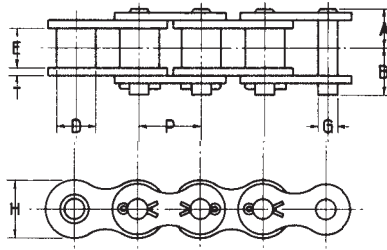
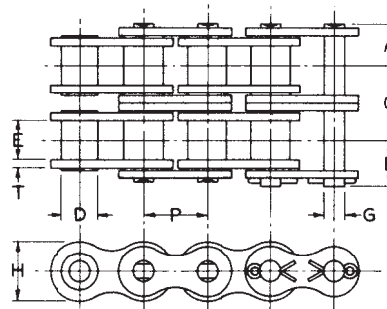
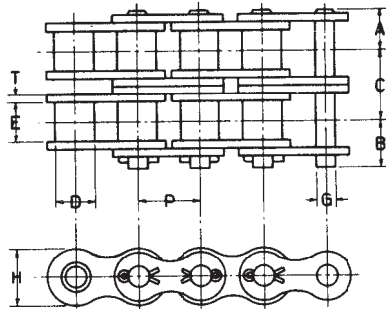

Table No.1

Specifications - Single Strand Roller Chain

Chain Pitch P	Chain No.	Chain		Dimensions						
		Average Tensile Strength Lbs.	Average Weight per Ft. Lbs.	Connecting Links		Rollers		Pins	Side Plates	
				A	B	D	E		G	H
Standard										
1/4"	25	875	.09	.156"	.188"	.130"	1/8"	.0905"	.234"	.030"
3/8"	35	2,100	.21	.233	.267	.200	3/16	.141	.350	.050
1/2"	41	2,000	.25	.256	.322	.306	1/4	.141	.383	.050
1/2"	40	3,700	.42	.315	.380	.312	5/16	.156	.466	.060
5/8"	50	6,100	.69	.395	.460	.400	3/8	.200	.584	.080
3/4"	60	8,500	1.00	.495	.586	.468	1/2	.234	.700	.094
1"	80	14,500	1.71	.637	.741	.625	5/8	.312	.934	.125
1 1/4"	100	24,000	2.58	.778	.923	.750	3/4	.375	1.166	.156
1 1/2"	120	34,000	3.87	.980	1.150	.875	1	.437	1.400	.187
1 3/4"	140	46,000	4.95	1.059	1.215	1.000	1	.500	1.634	.219
2"	160	58,000	6.61	1.261	1.451	1.125	1 1/4	.562	1.866	.250
2 1/2"	200	95,000	10.96	1.560	1.777	1.562	1 1/2	.781	2.250	.312



Double Strand—Riveted



Double Strand—Cottered

Table No.1

Specifications - Double Strand Roller Chain

Chain Pitch P	Chain No.	Chain		Dimensions							
		Average Tensile Strength Lbs.	Average Weight per Ft. Lbs.	Connecting Links		Spacing	Rollers		Pins	Side Plates	
				A	B	C	D	E		G	H
STANDARD											
3/8"	35-2	4,200	.40	.233"	.267"	.400"	.200"	3/16"	.141"	.350"	.050"
1/2"	40-2	7,400	.82	.315	.380	.564	.312	5/16	.156	.466	.060
5/8"	50-2	12,200	1.36	.395	.460	.730	.400	3/8	.200	.584	.080
3/4"	60-2	17,000	1.99	.495	.586	.904	.468	1/2	.234	.700	.094
1"	80-2	29,000	3.40	.637	.741	1.158	.625	5/8	.312	.934	.125
1 1/4"	100-2	48,000	5.10	.778	.923	1.406	.750	3/4	.375	1.166	.156
1 1/2"	120-2	68,000	7.65	.980	1.150	1.791	.875	1	.437	1.400	.187
1 3/4"	140-2	92,000	9.80	1.059	1.215	1.933	1.000	1	.500	1.634	.219
2"	160-2	116,000	13.10	1.261	1.451	2.327	1.125	1 1/4	.562	1.866	.250
2 1/2"	200-2	190,000	21.50	1.560	1.777	2.912	1.562	1 1/2	.781	2.250	.312
3"	240-2	260,000	33.20	1.895	2.187	3.458	1.875	1 7/8	.937	2.800	.375
LL											
1/2"	40-2 LL	6,800	.82	.312"	.362"	.566"	.312"	5/16"	.156"	.475"	.060"
5/8"	50-2 LL	11,000	1.38	.389	.435	.713	.400	3/8	.200	.594	.080
3/4"	60-2 LL	15,000	2.08	.485	.605	.897	.468	1/2	.234	.713	.094
1"	80-2 LL	26,000	3.54	.621	.774	1.153	.625	5/8	.312	.950	.125

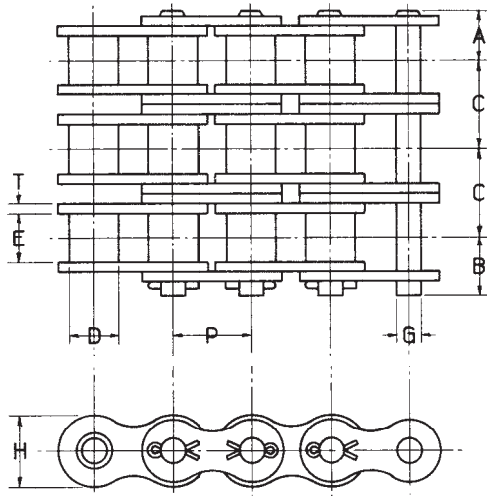

Table No.1

Specifications - Triple Strand Roller Chain

Chain Pitch P	Chain No.	Chain		Dimensions							
		Average Tensile Strength Lbs.	Average Weight per Ft. Lbs.	Connecting Links		Spacing	Rollers		Pins	Side Plates	
				A	B	C	D	E	G	H	T
TRIPLE STRAND - STANDARD											
3/8"	35-3	6,300	.66	.233"	.267"	.400"	.200"	3/16"	.141"	.350"	.050"
1/2"	40-3	11,100	1.23	.315	.380	.564	.312	5/16	.156	.466	.060
5/8"	50-3	18,300	2.02	.395	.460	.730	.400	3/8	.200	.584	.080
3/4"	60-3	25,500	2.96	.495	.586	.904	.468	1/2	.234	.700	.094
1"	80-3	43,500	5.09	.637	.741	1.158	.625	5/8	.312	.934	.125

DESIGN and INSTALLATION

Roller Chain Drives are intended for power transmissions between two or more parallel shafts on short or medium centers with relatively slow speed driving units. Horsepower Ratings shown on pages G-58 to G-62 are those recommended and copyrighted in 1960 by the Association of Roller and Silent Chain Manufacturers. Using a chain length of approximately 100 pitches, with recommended lubrication, on properly aligned sprockets, approximately 15,000 hours of service life at full load operation may be expected. The capacity of a chain drive is determined by the speed of the smaller sprocket, the number of teeth in the smaller sprocket and the chain size.

The horsepower ratings in these tables are based upon normal lubricated operation of drive and will, in most cases, serve as a guide for determining the chain size and minimum number of teeth required for the driving sprocket. From known ratio or speeds a selection of proper drive can be made from Horsepower Tables Pages G-58 to G-62.

Chain size can be selected for drives with slower speeds than shown in the rating tables on pages G-58 to G-62 by using a maximum chain pull of 10% of the average tensile strength of the chain.

$$\text{Chain Pull (Working Load)} = \frac{\text{HP} \times 33,000}{\text{F.P.M.}} \quad \text{or} \quad \frac{\text{Torque in Inch-Pounds}}{\text{Pitch Radius of Sprocket}}$$

For Example, assuming that 7000 Inch-Pounds of Torque is required and a Sprocket with approximately 6.0" Pitch Diameter is to be used:

$$\frac{7000}{3} = 2333 \times 10 = \text{chain tensile strength required.}$$

From Page G-14, note that No. 100 chain with a tensile strength of 24,000 lbs. is adequate.

WARNING—Browning® Roller Chain must not be used for hoisting applications.

GUIDELINES TO PROPER CHAIN DRIVE DESIGN

These guidelines are intended to assist in proper designing and installation of chain drives. They are not hard fast rules but good rules to follow.

- 1— Overload Service Factors, Shown on Page G-20 should be applied.
- 2— Select small sprockets of 17 teeth or more for moderate speed drives, and 21 teeth or more high speed drives. Sprockets with fewer teeth may be used for very slow speed drives. Speed ratio should not exceed 7 to 1 in a single drive. Use two reductions for unusually high ratios.
- 3— Select drives to operate at speeds somewhat below the recommended maximum for increased

smoothness and quiet operation, using small sprockets with 17 to 24 or more teeth.

- 4— For drives requiring a greater amount of horsepower than can be transmitted by the largest recommended size chain, select two, three or more strands of multiple chain of appropriate size.
- 5— For high speed drives select the smallest pitch chain practicable.
- 6— For very slow speeds, be sure drive is smoothly loaded and well lubricated.
- 7— The top span of chain on a horizontal shaft drive should be the tight side.
- 8— For the average application use 30 to 50 pitches of chain as the Center Distance, with a maximum of 80 pitches. Shorter centers, as low as 20 pitches, may be used for pulsating loads. Do not use long centers with small sprockets and pulsating loads.
- 9— Chain wrap should be at least 120° of the small sprocket, or 1/3 of the teeth. For ratios over 3 to 1 the center distance must be not less than the difference between the pitch diameters of the two sprockets.
- 10— Chain length must be in integral number of pitches. If possible use an even number of links and avoid use of offset links.
- 11— Provide adequate adjustment for mounting of chain and subsequent take-up. Be sure shafts are parallel, sprockets are in proper alignment and that chain spans are not touching.
- 12— Where idler sprockets are used, at least 3 teeth of the idler should engage the chain. When the idler is placed outside the closed span it should be placed nearer the small sprocket, and when inside the closed span it should be placed nearer the large sprocket.
- 13— Provide wire mesh or sheet metal guards for protection of both drive and personnel.
- 14— Proper Lubrication will reduce the noise of a chain drive and is necessary to obtain the expected chain life. In general lubrication, as applied to chain drives, may be grouped into three classes:
 - a. Manual or Drip Lubrication.
 - b. Bath or Disc Lubrication.
 - c. Oil Stream Lubrication.

Recommended lubrication is given in conjunction with the horsepower ratings on pages G-58 to G-62.

- 15— A smooth operating chain drive should have a slight sag in the chain. New chains should be installed under slight tension as they will elongate a small amount due to seating of pins and bushing during the first few days of operation. Chains on drives having near vertical centers should be kept reasonably tight.

DESIGN and INSTALLATION

- 16— Roller chain should be kept in good condition by proper lubrication and occasional cleaning. Worn out chain should be replaced by a complete new chain rather than by replacing a few worn parts. Worn sprockets should be replaced when new chain is installed as deformed teeth will damage the chain.
- 17— Wherever possible select drives using stock sprockets. If the larger sprocket required for a given ratio is not a stock size, try changing the size of the small sprocket to obtain a satisfactory ratio with a stock larger sprocket. Use hardened sprockets for longer drive life.
- 18— Necessary data for drive selection:
- Horsepower, Speed, and Type of Drive.
 - Type and Speed of Driven Unit.
 - Operating Conditions and Peak Load.
 - Shaft Diameters and Keyseats.
 - Desired Center Distance and Allowable Variations.
 - Space Limitations if any.
- 19— Chain Length in pitches may be calculated from the following formula:
- Where C = Center Distance in inches
 L = Chain Length in number of pitches (Links).
 N = Number of Teeth in Large Sprocket.
 n = Number of Teeth in Small Sprocket.
 P = Chain Pitch.
- Formula No. 1 (Approximate Chain Length)
- $$L = \frac{N+n}{2} + \frac{2C}{P}$$
- This approximate Chain Length is usually close enough as most chain is furnished in 10 ft. packages, but if more accurate length is required solve Formula No. 2.
- Formula No. 2 (Approximate Chain Length)
- $$L = \frac{2C}{P} + \frac{N+n}{2} + \frac{.1013(N-n)^2}{4C}$$
- CAUTION**— Install guards according to applicable local and national codes.

EXAMPLE — CHAIN DRIVE SELECTION

- A. Determine the Design Horsepower Rating of the Drive.**
 From Page G-57 note that 1.3 is the Service Factor for a Pan Conveyor driven by an electric Motor.
 $1.3 \times 15 = 19.5$ Design Horsepower.
- B. Determine the Chain Size and Number of Teeth in the Small Sprocket.**
 From Table No. 1, Page G-60 note that No. 100 Chain on a 19 tooth sprocket at 200 RPM is rated at 21.7 HP.
- C. Determine the Speed Ratio by Dividing the Driver Speed by the Desired Driven Speed.**
 $\frac{200}{105} = 1.90$ Ratio
- D. Determine the Number of Teeth for the Large Sprocket.**
 Multiply the Number of Teeth in the Small Sprocket by the Ratio.
 $19 \times 1.9 = 36.1$ Teeth. Use 36 Teeth.
- E. Determine Approximate Chain Length required**
 See Approximate Chain Length Formula above. $N + n$
- $$L = \frac{N+n}{2} + \frac{2C}{P}$$
- $$L = \frac{36 + 19}{2} + \frac{2 \times 38}{1.25}$$
- $$= 88.3 \text{ Pitches}$$
- $$88.3 \text{ (Pitches)} \times 1.25 \text{ (Pitch)} = 110.38 \text{ inches}$$
- $$\frac{110.38}{12} = 9.19 \text{ Feet of Chain}$$
- Note**—If exact length of chain is required refer to Formula No. 2.
- F. List Drive Components. (H-8)**
- 1, H100Q19 Driver Sprocket
 - 1, Q1 X 2 1/8 Bushing
 - 1, 100R36 Driven Sprocket
 - 1, R1 X 2 15/16 Bushing
 - 10 Feet, No. 100 CP Chain
- (Approximately 9.19 feet is required—standard package is 10 Feet).
- Note**—From the Stock Sprocket Listing and Interchange for No. 100 Sprockets on Page H-8 the following are available.
- Driver Sprockets:
 H100Q19, H100E19, H100TB19, 100A19 and 100B19
- Driven Sprockets:
 100R36, 100E36, 100A36 and 100B36
- The H100Q19 was selected because it is shaft ready (no reworking necessary) using the Browning Split Taper bushing and has hardened teeth for longer life. The 100A19 and the 100B19 would have to be reworked and do not have hardened Teeth.
- The 100R36 was selected because it is shaft ready.



OVERLOAD SERVICE FACTORS

The proper selection of a chain drive should include consideration of all the maximum conditions under which the drive will operate. The following information is a guide to determining the proper service factor for various operating conditions.

There are three classifications of operating conditions and three classifications of power source. The following table combines these classifications to arrive at the proper service factor.

Table No. 1 Service Factors

Type of Load	Type of Power Source		
	Internal Combustion Engine Hydraulic Drive	Electric Motor or Turbine	Internal Combustion Engine Mechanical Drive
Smooth	1.0	1.0	1.2
Moderate Shock	1.2	1.3	1.4
Heavy Shock	1.4	1.5	1.7

The following table gives the type of load classification for various applications. If a drive is required for an application which is not listed, choose the classification of the application closest in characteristics to the one desired.

Table No. 2 Load Classifications for Common Applications

Driven Equipment	Internal Combustion Engine Hydraulic Drive	Electric Motor or Turbine	Internal Combustion Engine Mechanical Drive
Agitators - Liquid	1.0	1.0	1.2
Clay Working Machinery- Pug Mills	1.2	1.3	1.4
- Brick Press	1.4	1.5	1.7
Conveyors - Uniformly Loaded (Apron, Bucket, Belt, Pan)	1.0	1.0	1.2
- Not Uniformly loaded (Apron, Bucket, Belt, Pan)	1.2	1.3	1.4
- Reciprocating	1.4	1.5	1.7
Cranes and Hoists - Medium Duty	1.2	1.3	1.4
- Heavy Duty	1.4	1.5	1.7
Fans and Blowers - Centrifugal	1.0	1.0	1.2
- Mine Fans, Positive Blowers	1.4	1.5	1.7
Food Machinery - Slicers, Mixers, Grinders	1.2	1.3	1.4
Laundry Machinery - Washers, Tumblers	1.2	1.3	1.4
Line Shafts - Light Duty	1.0	1.0	1.2
- Heavy Duty	1.4	1.5	1.7
Machinery - Uniform Load Non-Reversing	1.0	1.0	1.2
- Moderate Pulsating Load Non-Reversing	1.2	1.3	1.4
- Shock and / or Variable Load - Reversing	1.4	1.5	1.7
Mills - Ball, Pebble, Tube	1.2	1.3	1.4
- Hammer, Rolling	1.4	1.5	1.7
Paper Machinery - Mixers, Calendars, etc.	1.4	1.5	1.7
Screens - Rotary	1.2	1.3	1.4
Textile Machinery - Calendars, Nappers, Soapers	1.2	1.3	1.4
- Carding	1.4	1.5	1.7

HORSEPOWER RATINGS - ANSI ROLLER CHAIN

Table No. 1

Chain Size	Pitch	Number of Teeth In Sprocket	Revolution Per Minute of Small Sprocket																			
			10	25	50	100	300	500	700	900	1200	1500	1800	2100	3000	3500	5000	6000	7000	8000	9000	10000
#25	1/4"	9	—	—	.02	.04	.12	.18	.25	.31	.41	.50	.58	.67	.93	1.06	.73	.56	.44	.36	.30	.26
		10	—	—	.03	.05	.13	.21	.28	.35	.45	.56	.65	.75	1.04	1.19	.86	.65	.52	.42	.35	.30
		11	—	—	.03	.05	.14	.23	.31	.39	.50	.62	.73	.83	1.15	1.32	.99	.75	.60	.49	.41	.35
		12	—	—	.03	.06	.16	.25	.34	.43	.55	.68	.80	.92	1.26	1.45	1.12	.86	.68	.56	.47	.40
		13	—	—	.04	.06	.17	.27	.37	.47	.60	.74	.87	1.00	1.38	1.58	1.27	.96	.77	.63	.53	.45
		14	—	—	.04	.07	.19	.30	.40	.50	.65	.80	.94	1.08	1.49	1.71	1.42	1.08	.86	.70	.59	.50
		15	—	—	.04	.08	.20	.32	.43	.54	.70	.86	1.01	1.17	1.61	1.85	1.57	1.20	.95	.78	.65	.56
		16	—	—	.04	.08	.22	.34	.47	.58	.76	.92	1.09	1.25	1.72	1.98	1.73	1.32	1.05	.86	.72	.61
		17	—	—	.05	.09	.23	.37	.50	.62	.81	.99	1.16	1.33	1.84	2.11	1.90	1.44	1.14	.94	.79	.67
		18	—	—	.05	.09	.25	.39	.53	.66	.86	1.05	1.24	1.42	1.96	2.25	2.07	1.57	1.25	1.02	.86	.73
		19	—	—	.05	.10	.26	.41	.56	.70	.91	1.11	1.31	1.50	2.07	2.38	2.24	1.70	1.35	1.11	.93	.79
		20	—	—	.06	.10	.28	.44	.59	.74	.96	1.17	1.38	1.59	2.19	2.52	2.42	1.84	1.46	1.20	1.00	.86
		21	—	—	.06	.11	.29	.46	.62	.78	1.01	1.24	1.46	1.68	2.31	2.66	2.60	1.98	1.57	1.29	1.08	.92
		22	—	—	.06	.11	.31	.48	.66	.82	1.07	1.30	1.53	1.76	2.43	2.79	2.79	2.12	1.69	1.38	1.16	.99
		23	—	—	.06	.12	.32	.51	.69	.86	1.12	1.37	1.61	1.85	2.55	2.93	2.98	2.27	1.80	1.47	1.24	1.06
		24	—	—	.07	.13	.34	.53	.72	.90	1.17	1.43	1.69	1.94	2.67	3.07	3.18	2.42	1.92	1.57	1.32	1.12
		25	—	—	.07	.13	.35	.56	.75	.94	1.22	1.50	1.76	2.02	2.79	3.21	3.38	2.57	2.04	1.67	1.40	1.20
		26	—	—	.07	.14	.37	.58	.79	.98	1.28	1.56	1.84	2.11	2.91	3.34	3.59	2.73	2.17	1.77	1.49	1.27
		28	—	—	.08	.15	.40	.63	.85	1.07	1.38	1.69	1.99	2.29	3.15	3.62	4.01	3.05	2.42	1.98	1.66	1.42
		30	—	—	.08	.16	.43	.68	.92	1.15	1.49	1.82	2.15	2.46	3.40	3.90	4.45	3.38	2.68	2.20	1.84	1.57
		32	—	—	.09	.17	.46	.73	.98	1.23	1.60	1.95	2.30	2.64	3.64	4.18	4.90	3.73	2.96	2.42	2.03	1.73
		35	—	—	.10	.19	.51	.80	1.08	1.36	1.76	2.15	2.53	2.91	4.01	4.61	5.60	4.26	3.38	2.77	2.32	1.98
		40	—	—	.12	.22	.58	.92	1.25	1.57	2.03	2.48	2.93	3.36	4.64	5.32	6.85	5.21	4.13	3.38	2.83	2.42
		45	—	—	.13	.25	.66	1.05	1.42	1.78	2.31	2.82	3.32	3.82	5.26	6.05	8.17	6.21	4.93	4.04	3.38	2.89
Lubrication		Type "A"									Type "B"						Type "C"					
#35	3/8"	9	—	—	.08	.15	.39	.62	.84	1.06	1.37	1.68	1.98	2.27	2.17	1.73	1.01	.77	.61	.50	.42	.35
		10	—	—	.09	.16	.44	.70	.95	1.19	1.54	1.88	2.21	2.54	2.55	2.03	1.18	.90	.71	.58	.49	.42
		11	—	—	.10	.18	.49	.77	1.05	1.31	1.70	2.08	2.45	2.82	2.94	2.33	1.37	1.04	.82	.67	.57	.48
		12	—	—	.11	.20	.54	.85	1.15	1.44	1.87	2.29	2.70	3.10	3.35	2.66	1.56	1.18	.94	.77	.64	.55
		13	—	—	.12	.22	.59	.93	1.26	1.57	2.04	2.49	2.94	3.38	3.77	3.00	1.75	1.33	1.06	.87	.73	.62
		14	—	—	.13	.24	.63	1.01	1.36	1.71	2.21	2.70	3.18	3.66	4.22	3.35	1.96	1.49	1.18	.97	.81	.69
		15	—	—	.14	.25	.68	1.08	1.47	1.84	2.38	2.91	3.43	3.94	4.68	3.71	2.17	1.65	1.31	1.07	.90	.77
		16	—	—	.15	.27	.73	1.16	1.57	1.97	2.55	3.12	3.68	4.22	5.15	4.09	2.40	1.82	1.45	1.18	.99	.85
		17	—	—	.16	.29	.78	1.24	1.68	2.10	2.73	3.33	3.93	4.51	5.64	4.48	2.62	2.00	1.58	1.30	1.09	.93
		18	—	—	.17	.31	.83	1.32	1.78	2.24	2.90	3.54	4.18	4.80	6.15	4.88	2.86	2.17	1.73	1.41	1.18	1.01
		19	—	—	.18	.33	.88	1.40	1.89	2.37	3.07	3.76	4.43	5.09	6.67	5.29	3.10	2.36	1.87	1.53	1.28	1.10
		20	—	—	.19	.35	.93	1.48	2.00	2.51	3.25	3.97	4.68	5.38	7.20	5.72	3.35	2.55	2.02	1.65	1.39	1.18
		21	—	—	.20	.37	.98	1.56	2.11	2.64	3.42	4.19	4.93	5.67	7.75	6.15	3.60	2.74	2.17	1.78	1.49	1.27
		22	—	—	.21	.38	1.03	1.64	2.22	2.78	3.60	4.40	5.19	5.96	8.21	6.59	3.86	2.94	2.33	1.91	1.60	1.37
		23	—	—	.22	.40	1.08	1.72	2.33	2.92	3.78	4.62	5.44	6.25	8.62	7.05	4.13	3.14	2.49	2.04	1.71	1.46
		24	—	—	.23	.42	1.14	1.80	2.44	3.05	3.96	4.84	5.70	6.55	9.02	7.51	4.40	3.35	2.66	2.17	1.82	1.56
		25	—	—	.24	.44	1.19	1.88	2.55	3.19	4.13	5.05	5.95	6.84	9.43	7.99	4.68	3.56	2.82	2.31	1.94	1.65
		26	—	—	.25	.46	1.24	1.96	2.66	3.33	4.31	5.27	6.21	7.14	9.84	8.47	4.96	3.77	3.00	2.45	2.05	1.75
		28	—	—	.27	.50	1.34	2.12	2.88	3.61	4.67	5.71	6.73	7.73	10.7	9.47	5.55	4.22	3.35	2.74	2.30	1.96
		30	—	—	.29	.54	1.45	2.29	3.10	3.89	5.03	6.15	7.25	8.33	11.5	10.5	6.15	4.68	3.71	3.04	2.55	2.17
		32	—	—	.31	.58	1.55	2.45	3.32	4.17	5.40	6.60	7.77	8.93	12.3	11.6	6.77	5.15	4.09	3.35	2.81	—
		35	—	—	.34	.64	1.71	2.70	3.66	4.59	5.95	7.27	8.56	9.84	13.6	13.2	7.75	5.90	4.68	3.83	3.21	—
		40	—	—	.39	.73	1.97	3.12	4.23	5.30	6.87	8.40	9.89	11.4	15.7	16.2	9.47	7.20	5.72	4.68	—	—
		45	—	—	.45	.83	2.24	3.55	4.80	6.02	7.80	9.53	11.2	12.9	17.8	19.3	11.3	8.59	6.82	—	—	—
Lubrication		Type "A"									Type "B"						Type "C"					
#41	1/2"	9	.02	.05	.10	.19	.51	.81	1.10	1.38	1.27	.91	.69	.55	.32	.25	.15	.11	.09	.07	—	—
		10	.03	.06	.11	.21	.57	.91	1.23	1.54	1.49	1.07	.81	.64	.38	.30	.17	.13	.11	.08	—	—
		11	.03	.07	.13	.24	.64	1.01	1.37	1.71	1.71	1.23	.93	.74	.43	.34	.20	.15	.12	.10	—	—
		12	.03	.07	.14	.26	.70	1.11	1.50	1.88	1.95	1.41	1.06	.84	.49	.39	.23	.17	.14	.11	—	—
		13	.04	.08	.15	.28	.76	1.21	1.63	2.05	2.20	1.59	1.20	.95	.56	.44	.26	.20	.16	.13	—	—
		14	.04	.09	.16	.31	.83	1.31	1.77	2.22	2.46	1.77	1.34	1.06	.62	.49	.29	.22	.17	.14	—	—
		15	.04	.09	.18	.33	.89	1.41	1.91	2.39	2.73	1.97	1.49	1.18	.69	.55	.32	.24	.19	.16	—	—
		16	.04	.10	.19	.36	.95	1.51	2.05	2.57	3.01	2.17	1.64	1.30	.76	.60	.35	.27	.21	.17	—	—
		17	.05	.11	.20	.38	1.02	1.61	2.18	2.74	3.29	2.37	1.79	1.42	.83	.66	.39	.29	.23	.19	—	—
		18	.05	.12	.22	.40	1.08	1.72	2.32	2.91	3.59	2.59	1.95	1.55	.91	.72	.42	.32	.25	—	—	—
		19	.05	.12	.23	.43	1.15	1.82	2.46	3.09	3.89	2.81	2.12	1.68	.98	.78	.46	.35	.28	—	—	—
		20	.06	.13	.24	.45	1.21	1.92	2.60	3.26	4.20	3.03	2.29	1.81	1.06	.84	.49	.38	.30	—	—	—
		21	.06	.14	.26	.48	1.28	2.03	2.74	3.44	4.46	3.26	2.46	1.95	1.14	.91	.53	.40	.32	—	—	—
		22	.06	.14	.27	.50	1.35	2.13	2.89	3.62	4.69	3.50	2.64	2.09	1.23	.97	.57	.43	.34	—	—	—
		23	.06	.15	.28	.53	1.41	2.24	3.03	3.80	4.92	3.74	2.82	2.24	1.31	1.04	.61	.46	.37	—	—	—
		24	.07	.16	.29	.55	1.48	2.34	3.17	3.97	5.15	3.98	3.01	2.39	1.40	1.11	.65	.49	.39	—	—	—
		25	.07	.17	.31	.57	1.55	2.45	3.31	4.15	5.38	4.23	3.20	2.54	1.49	1.18	.69	.53	—	—	—	—
		26	.07	.17	.32	.60	1.61	2.55	3.46	4.33	5.61	4.49	3.39	2.69	1.58	1.25	.73	.56	—	—	—	—
		28	.08	.19	.35	.65	1.75	2.77	3.74	4.69	6.08	5.02	3.79	3.01	1.76	1.40	.82	.62	—	—	—	—
		30	.08	.20	.38	.70	1.88	2.98	4.03	5.06	6.55	5.57	4.20	3.33								



HORSEPOWER RATINGS - ANSI ROLLER CHAIN

Table No. 1

Chain Size	Pitch	Number of Teeth In Sprocket	Revolution Per Minute of Small Sprocket																					
			10	25	50	100	200	300	400	500	700	900	1000	1200	1400	1600	1800	2100	3000	3500	4000	4500		
#40	1/2"	9	.04	.10	.19	.35	.65	.93	1.21	1.48	2.00	2.51	2.75	3.25	3.73	4.12	3.45	2.74	1.60	1.27	1.04	.89		
		10	.05	.11	.20	.39	.73	1.04	1.35	1.65	2.24	2.81	3.09	3.64	4.18	4.71	4.04	3.21	1.88	1.49	1.22	1.04		
		11	.05	.12	.23	.43	.80	1.16	1.50	1.83	2.48	3.11	3.42	4.03	4.63	5.22	4.66	3.70	2.17	1.72	1.41	1.21		
		12	.06	.14	.25	.47	.88	1.27	1.65	2.01	2.73	3.42	3.76	4.43	5.09	5.74	5.31	4.22	2.47	1.96	1.60	1.37		
		13	.06	.15	.28	.52	.96	1.39	1.80	2.20	2.97	3.73	4.10	4.83	5.55	6.26	5.99	4.76	2.79	2.21	1.81	1.55		
		14	.07	.16	.30	.56	1.04	1.50	1.95	2.38	3.22	4.04	4.44	5.23	6.01	6.78	6.70	5.31	3.11	2.47	2.02	1.73		
		15	.07	.17	.32	.60	1.12	1.62	2.10	2.56	3.47	4.35	4.78	5.64	6.47	7.30	7.43	5.89	3.45	2.74	2.24	1.92		
		16	.08	.19	.35	.65	1.20	1.74	2.25	2.75	3.72	4.66	5.13	6.04	6.94	7.83	8.18	6.49	3.80	3.02	2.47	2.12		
		17	.08	.20	.37	.69	1.29	1.85	2.40	2.93	3.97	4.98	5.48	6.45	7.41	8.36	8.96	7.11	4.17	3.31	2.71	2.32		
		18	.09	.21	.39	.73	1.37	1.97	2.55	3.12	4.22	5.30	5.82	6.86	7.88	8.89	9.76	7.75	4.54	3.60	2.95	2.53		
		19	.09	.22	.42	.78	1.45	2.09	2.71	3.31	4.48	5.62	6.17	7.27	8.36	9.42	10.5	8.40	4.92	3.91	3.20	2.74		
		20	.10	.24	.44	.82	1.53	2.21	2.86	3.50	4.73	5.94	6.53	7.69	8.83	9.96	11.1	9.07	5.31	4.22	3.45	2.96		
		21	.11	.25	.46	.87	1.62	2.33	3.02	3.69	4.99	6.26	6.88	8.11	9.31	10.5	11.7	9.76	5.72	4.54	3.71	3.18		
		22	.11	.26	.49	.91	1.70	2.45	3.17	3.88	5.25	6.58	7.23	8.52	9.79	11.0	12.3	10.5	6.13	4.87	3.98	3.46		
		23	.12	.27	.51	.96	1.78	2.57	3.33	4.07	5.51	6.90	7.59	8.94	10.3	11.6	12.9	11.2	6.55	5.20	4.26	3.65		
		24	.13	.29	.54	1.00	1.87	2.69	3.48	4.26	5.76	7.23	7.95	9.36	10.8	12.1	13.5	11.9	6.99	5.54	4.54	3.89		
		25	.13	.30	.56	1.05	1.95	2.81	3.64	4.45	6.02	7.55	8.30	9.78	11.2	12.7	14.1	12.7	7.43	5.89	4.82	4.13		
		26	.14	.31	.58	1.09	2.04	2.93	3.80	4.64	6.28	7.88	8.66	10.2	11.7	13.2	14.7	13.5	7.88	6.25	5.12	4.39		
		28	.15	.34	.63	1.18	2.20	3.18	4.11	5.03	6.81	8.54	9.39	11.1	12.7	14.3	15.9	15.0	8.80	6.99	5.72	4.90		
		30	.16	.37	.68	1.27	2.38	3.42	4.43	5.42	7.33	9.20	10.1	11.9	13.7	15.4	17.2	16.7	9.76	7.75	6.34	5.44		
32	.17	.39	.73	1.36	2.55	3.67	4.75	5.81	7.86	9.86	10.8	12.8	14.7	16.5	18.4	18.4	10.8	8.54	6.99	5.99				
35	.19	.43	.81	1.50	2.81	4.04	5.24	6.40	8.66	10.9	11.9	14.1	16.2	18.2	20.3	21.0	12.3	9.76	7.99	6.85				
40	.22	.50	.93	1.74	3.24	4.67	6.05	7.39	10.0	12.5	13.8	16.3	18.7	21.1	23.4	25.7	15.0	11.9	9.76	8.37				
45	.25	.57	1.06	1.97	3.68	5.30	6.87	8.40	11.4	14.2	15.7	18.5	21.2	23.9	26.6	30.5	17.9	14.2	11.7	—				
Lubrication			Type "A"					Type "B"					Type "C"											
#50	5/8"	9	.09	.19	.36	.67	1.26	1.81	2.35	2.87	3.89	4.88	5.36	6.32	6.02	4.92	4.13	3.27	1.92	1.52	1.25	1.04		
		10	.10	.22	.41	.76	1.41	2.03	2.63	3.22	4.36	5.46	6.01	7.08	7.05	5.77	4.83	3.84	2.25	1.78	1.46	1.22		
		11	.11	.24	.45	.84	1.56	2.25	2.92	3.57	4.83	6.06	6.66	7.85	8.13	6.65	5.58	4.42	2.59	2.06	1.68	1.41		
		12	.12	.26	.49	.92	1.72	2.47	3.21	3.92	5.31	6.65	7.31	8.62	9.26	7.58	6.35	5.04	2.95	2.34	1.92	1.61		
		13	.13	.29	.54	1.00	1.87	2.70	3.50	4.27	5.78	7.25	7.97	9.40	10.4	8.55	7.16	5.69	3.33	2.64	2.16	1.81		
		14	.14	.31	.58	1.09	2.03	2.92	3.79	4.63	6.27	7.86	8.64	10.2	11.7	9.55	8.01	6.35	3.72	2.95	2.42	2.03		
		15	.15	.34	.63	1.17	2.19	3.15	4.08	4.99	6.75	8.47	9.31	11.0	12.6	10.6	8.88	7.05	4.13	3.27	2.68	2.25		
		16	.16	.36	.67	1.26	2.34	3.38	4.37	5.35	7.24	9.08	9.98	11.8	13.5	11.7	9.78	7.76	4.55	3.61	2.95	2.47		
		17	.17	.39	.72	1.34	2.50	3.61	4.67	5.71	7.73	9.69	10.7	12.6	14.4	12.8	10.7	8.50	4.98	3.95	3.23	2.71		
		18	.18	.41	.76	1.43	2.66	3.83	4.97	6.07	8.22	10.3	11.3	13.4	15.3	13.9	11.7	9.26	5.42	4.30	3.52	2.95		
		19	.19	.43	.81	1.51	2.82	4.07	5.27	6.44	8.72	10.9	12.0	14.2	16.3	15.1	12.7	10.0	5.88	4.67	3.82	3.20		
		20	.20	.46	.86	1.60	2.98	4.30	5.57	6.80	9.21	11.5	12.7	15.0	17.2	16.3	13.7	10.8	6.35	5.04	4.13	3.46		
		21	.21	.48	.90	1.69	3.14	4.53	5.87	7.17	9.71	12.2	13.4	15.8	18.1	17.6	14.7	11.7	6.84	5.42	4.44	3.72		
		22	.22	.51	.95	1.77	3.31	4.76	6.17	7.54	10.2	12.8	14.1	16.6	19.1	18.8	15.8	12.5	7.33	5.82	4.76	3.99		
		23	.23	.53	1.00	1.86	3.47	5.00	6.47	7.91	10.7	13.4	14.8	17.4	20.0	20.1	16.9	13.4	7.84	6.22	5.09	4.27		
		24	.25	.56	1.04	1.95	3.63	5.23	6.78	8.29	11.2	14.1	15.5	18.2	20.9	21.4	18.0	14.3	8.35	6.63	5.42	4.55		
		25	.26	.58	1.09	2.03	3.80	5.47	7.08	8.66	11.7	14.7	16.2	19.0	21.9	22.8	19.1	15.2	8.88	7.05	5.77	4.83		
		26	.27	.61	1.14	2.12	3.96	5.70	7.39	9.03	12.2	15.3	16.9	19.9	22.8	24.2	20.3	16.1	9.42	7.47	6.12	5.13		
		28	.29	.66	1.23	2.30	4.29	6.18	8.01	9.79	13.2	16.6	18.3	21.5	24.7	27.0	22.6	18.0	10.5	8.35	6.84	5.73		
		30	.31	.71	1.33	2.48	4.62	6.66	8.63	10.5	14.3	17.9	19.7	23.2	26.6	30.0	25.1	19.9	11.7	9.26	7.58	—		
32	.33	.76	1.42	2.66	4.96	7.14	9.25	11.3	15.3	19.2	21.1	24.9	28.6	32.2	27.7	22.0	12.9	10.2	8.35	—				
35	.37	.84	1.57	2.93	5.46	7.86	10.2	12.5	16.9	21.1	23.2	27.4	31.5	35.5	31.6	25.1	14.7	11.7	9.55	—				
40	.43	.97	1.81	3.38	6.31	9.08	11.8	14.4	19.5	24.4	26.8	31.6	36.3	41.0	38.7	30.7	18.0	14.3	—	—				
45	.48	1.10	2.06	3.84	7.16	10.3	13.4	16.3	22.1	27.7	30.5	35.9	41.3	46.5	46.1	36.6	21.4	—	—	—				
Lubrication			Type "A"					Type "B"					Type "C"											
#60	3/4"	9	.15	.33	.62	1.16	2.16	3.12	4.04	4.94	6.68	8.38	9.21	8.77	6.96	5.70	4.77	3.84	2.22	1.76	1.44	1.21		
		10	.16	.37	.70	1.30	2.43	3.49	4.53	5.53	7.49	9.39	10.3	10.3	8.15	6.67	5.59	4.50	2.60	2.06	1.69	1.41		
		11	.18	.41	.77	1.44	2.69	3.87	5.02	6.13	8.30	10.4	11.4	11.9	9.41	7.70	6.45	5.19	3.00	2.38	1.95	1.63		
		12	.20	.45	.85	1.58	2.95	4.25	5.51	6.74	9.12	11.4	12.6	13.5	10.7	8.77	7.35	5.92	3.42	2.71	2.22	1.86		
		13	.22	.50	.92	1.73	3.22	4.64	6.01	7.34	9.94	12.5	13.7	15.2	12.1	9.89	8.29	6.67	3.85	3.06	2.50	—		
		14	.24	.54	1.00	1.87	3.49	5.02	6.51	7.96	10.8	13.5	14.8	17.0	13.5	11.1	9.26	7.46	4.31	3.42	2.80	—		
		15	.25	.58	1.08	2.01	3.76	5.41	7.01	8.57	11.6	14.5	16.0	18.8	15.0	12.3	10.3	8.25	4.77	3.79	3.10	—		
		16	.27	.62	1.16	2.16	4.03	5.80	7.52	9.19	12.4	15.6	17.1	20.2	16.5	13.5	11.3	9.11	5.26	4.17	3.42	—		
		17	.29	.66	1.24	2.31	4.30	6.20	8.03	9.81	13.3	16.7	18.3	21.6	18.1	14.8	12.4	9.99	5.76	4.57	3.74	—		
		18	.31	.70	1.31	2.45	4.58	6.59	8.54	10.4	14.1	17.7	19.5	22.9	19.7	16.1	13.5	10.8	6.28	4.98	4.08	—		
		19	.33	.75	1.39	2.60	4.85	6.99	9.05	11.1	15.0	18.8	20.6	24.3	21.4	17.5	14.6	11.8	6.81	5.40	4.42	—		
		20	.35	.79	1.47	2.75	5.13	7.38	9.57	11.7	15.8	19.8	21.8	25.7	23.1	18.9	15.8	12.7	7.35	5.83	—	—		
		21	.36	.83	1.55	2.90	5.40	7.78	10.1	12.3	16.7	20.9	23.0	27.1	24.8	20.3	17.0	13.7	7.91	6.28	—	—		
		22	.38	.87	1.63	3.05	5.68	8.19	10.6	13.0	17.5	22.0	24.2	28.5	26.6	21.8	18.2	14.7	8.48	6.73	—	—		
		23	.40	.92	1.71	3.19	5.96	8.59	11.1	13.6	18.4	23.1	25.4	29.9	28.4	23.3	19.5	15.7	9.07	7.19	—	—		
		24	.42	.96	1.79	3.35	6.24	8.99	11.6	14.2	19.3	24.2	26.6	31.3	30.3	24.8	20.8	16.7	9.66	7.67	—	—		
		25	.44	1.00	1.87																			



HORSEPOWER RATINGS - ANSI ROLLER CHAIN

Table No.1

Chain Size	Pitch	Number of Teeth in Sprocket	Revolution Per Minute of Small Sprocket																						
			10	25	50	100	150	200	300	400	500	600	700	800	900	1000	1100	1200	1400	1600	1800	2000			
#80	1"	9	.34	.78	1.45	2.71	3.90	5.05	7.28	9.43	11.5	13.6	15.6	17.6	17.0	14.5	12.6	11.0	8.76	7.17	6.01	5.13			
		10	.38	.87	1.63	3.03	4.37	5.66	8.16	10.6	12.9	15.2	17.5	19.7	19.9	17.0	14.7	12.9	10.3	8.40	7.04	6.01			
		11	.42	.97	1.80	3.36	4.84	6.28	9.04	11.7	14.3	16.9	19.4	21.9	23.0	19.6	17.0	14.9	11.8	9.69	8.12	6.93			
		12	.47	1.06	1.98	3.69	5.32	6.89	9.93	12.9	15.7	18.5	21.3	24.0	26.2	22.3	19.4	17.0	13.5	11.0	9.25	7.90			
		13	.51	1.16	2.16	4.03	5.80	7.52	10.8	14.0	17.1	20.2	23.2	26.2	29.1	25.2	21.8	19.2	15.2	12.5	10.4	8.91			
		14	.55	1.25	2.34	4.36	6.29	8.14	11.7	15.2	18.6	21.9	25.1	28.4	31.5	28.2	24.4	21.4	17.0	13.9	11.7	9.96			
		15	.59	1.35	2.52	4.70	6.77	8.77	12.6	16.4	20.0	23.6	27.1	30.6	34.0	31.2	27.1	23.8	18.9	15.4	12.9	11.0			
		16	.63	1.45	2.70	5.04	7.26	9.41	13.5	17.6	21.5	25.3	29.0	32.8	36.4	34.4	29.8	26.2	20.8	17.0	14.2	12.2			
		17	.68	1.55	2.88	5.38	7.75	10.0	14.5	18.7	22.9	27.0	31.0	35.0	38.9	37.7	32.7	28.7	22.7	18.6	15.6	13.3			
		18	.72	1.64	3.07	5.72	8.25	10.7	15.4	19.9	24.4	28.7	33.0	37.2	41.4	41.1	35.6	31.2	24.8	20.3	17.0	14.5			
		19	.76	1.74	3.25	6.07	8.74	11.3	16.3	21.1	25.8	30.4	35.0	39.4	43.8	44.5	38.6	33.9	26.9	22.0	18.4	15.7			
		20	.81	1.84	3.44	6.41	9.24	12.0	17.2	22.3	27.3	32.2	37.0	41.7	46.3	48.1	41.7	36.6	29.0	23.8	19.9	17.0			
		21	.85	1.94	3.62	6.76	9.74	12.6	18.2	23.5	28.8	33.9	39.0	43.9	48.9	51.7	44.8	39.4	31.2	25.6	21.4	18.3			
		22	.90	2.04	3.81	7.11	10.2	13.3	19.1	24.8	30.3	35.7	41.0	46.2	51.4	55.5	48.1	42.2	33.5	27.4	23.0	19.6			
		23	.94	2.14	4.00	7.46	10.7	13.9	20.1	26.0	31.8	37.4	43.0	48.5	53.9	59.3	51.4	45.1	35.8	29.3	24.6	21.0			
		24	.98	2.24	4.19	7.81	11.3	14.6	21.0	27.2	33.2	39.2	45.0	50.8	56.4	62.0	54.8	48.1	38.2	31.2	26.2	22.3			
		25	1.03	2.34	4.37	8.16	11.8	15.2	21.9	28.4	34.7	40.9	47.0	53.0	59.0	64.8	58.2	51.1	40.6	33.2	27.8	23.8			
		26	1.07	2.45	4.56	8.52	12.3	15.9	22.9	29.7	36.2	42.7	49.1	55.3	61.5	67.6	61.8	54.2	43.0	35.2	29.5	25.2			
		28	1.16	2.65	4.94	9.23	13.3	17.2	24.8	32.1	39.3	46.3	53.2	59.9	66.7	73.3	69.0	60.6	48.1	39.4	33.0	28.2			
		30	1.25	2.85	5.33	9.94	14.3	18.5	26.7	34.6	42.3	49.9	57.3	64.6	71.8	78.9	76.6	67.2	53.3	43.6	36.0	31.2			
32	1.34	3.06	5.71	10.7	15.3	19.9	28.6	37.1	45.4	53.5	61.4	69.2	77.0	84.6	84.3	74.0	58.7	48.1	40.3	34.4					
35	1.48	3.37	6.29	11.7	16.9	21.9	31.6	40.9	50.0	58.9	67.6	76.3	84.8	93.3	96.5	84.7	67.2	55.0	46.1	39.4					
40	1.71	3.89	7.27	13.6	19.5	25.3	36.4	47.2	57.7	68.0	78.1	88.1	99.0	108.	117.	103.	82.1	67.2	0	0					
45	1.94	4.42	8.25	15.4	22.2	28.7	41.4	53.6	65.6	77.2	88.7	100.	111.	122.	133.	123.	98.0	80.2	0	0					
Lubrication			Type "A"					Type "B"					Type "C"												
#100	1 1/4"	10	.73	1.67	3.11	5.81	8.37	10.8	15.6	20.2	24.7	29.2	33.5	38.4	23.8	20.3	17.6	15.5	12.3	10.0	8.42	7.19			
		11	.81	1.85	3.45	6.44	9.28	12.0	17.3	22.4	27.4	32.3	37.1	42.1	32.8	27.5	23.4	20.3	17.8	14.2	11.6	9.71	0		
		12	.89	2.03	3.79	7.08	10.2	13.2	19.0	24.6	30.1	35.5	40.8	46.1	37.3	31.3	26.7	23.2	20.3	16.1	13.2	11.1	0		
		13	.97	2.22	4.13	7.72	11.1	14.4	20.7	26.9	32.8	38.7	44.5	50.3	42.1	35.3	30.1	26.1	22.9	18.2	14.9	12.5	0		
		14	1.05	2.40	4.48	8.36	12.0	15.6	22.5	29.1	35.6	41.9	48.2	54.4	47.0	39.4	33.7	29.2	25.6	20.3	16.6	13.9	0		
		15	1.13	2.59	4.83	9.01	13.0	16.8	24.2	31.4	38.3	45.2	51.9	58.2	43.7	37.3	32.4	28.4	22.5	18.4	15.5	0	0		
		16	1.22	2.77	5.17	9.66	13.9	18.0	26.0	33.6	41.1	48.4	55.6	62.5	48.2	41.1	35.7	31.3	24.8	20.3	17.0	0	0		
		17	1.30	2.96	5.52	10.3	14.8	19.2	27.7	35.9	43.9	51.7	59.4	66.8	52.8	45.0	39.0	34.3	27.2	22.3	0	0	0		
		18	1.38	3.15	5.88	11.0	15.8	20.5	29.5	38.2	46.7	55.0	63.2	70.8	68.6	57.5	49.1	42.5	37.3	29.6	24.2	0	0		
		19	1.46	3.34	6.23	11.6	16.7	21.7	31.2	40.5	49.5	58.3	67.0	74.4	82.3	62.3	53.2	46.1	40.5	32.1	26.3	0	0		
		20	1.55	3.53	6.58	12.3	17.7	22.9	33.0	42.8	52.3	61.6	70.8	79.8	87.3	67.3	57.5	49.8	43.7	34.7	28.4	0	0		
		21	1.63	3.72	6.94	13.0	18.7	24.2	34.8	45.1	55.1	65.0	74.6	84.2	92.4	72.4	61.8	53.6	47.0	37.3	30.6	0	0		
		22	1.71	3.91	7.30	13.6	19.6	25.4	36.6	47.4	58.0	68.3	78.5	88.5	97.7	77.7	66.3	57.5	50.4	40.0	32.8	0	0		
		23	1.80	4.10	7.66	14.3	20.6	26.7	38.4	49.8	60.8	71.7	82.3	92.8	102.8	83.0	70.9	61.4	53.9	42.8	35.0	0	0		
		24	1.88	4.30	8.02	15.0	21.5	27.9	40.2	52.1	63.7	75.0	86.2	97.2	107.8	88.5	75.6	65.5	57.5	45.6	37.3	0	0		
		25	1.97	4.49	8.38	15.6	22.5	29.2	42.0	54.4	66.6	78.4	90.1	102.	113.	94.1	80.3	69.6	61.1	48.5	0	0	0		
		26	2.05	4.68	8.74	16.3	23.5	30.4	43.8	56.8	69.4	81.8	94.0	106.	119.	99.8	85.2	73.8	64.8	51.4	0	0	0		
		28	2.22	5.07	9.47	17.7	25.5	33.0	47.5	61.5	75.2	88.6	102.	115.	129.	102.	92.2	82.5	72.4	57.5	0	0	0		
		30	2.40	5.47	10.2	19.0	27.4	35.5	51.2	66.3	81.0	95.5	110.	124.	140.	106.	91.5	80.3	63.7	0	0	0	0		
		32	2.57	5.86	10.9	20.4	29.4	38.1	54.9	71.1	86.9	102.	118.	133.	150.	116.	101.	88.5	70.2	0	0	0	—		
35	2.83	6.46	12.0	22.5	32.5	42.0	60.4	78.3	95.7	113.	130.	146.	165.	133.	115.	101.	0	0	0	0	—				
40	3.27	7.46	13.9	26.0	37.4	48.5	69.8	90.4	111.	130.	150.	169.	188.	163.	141.	124.	0	0	—	—	—				
45	3.71	8.47	15.8	29.5	42.5	55.0	79.3	103.	126.	148.	170.	192.	213.	194.	0	0	0	0	—	—	—				
Lubrication			Type "A"					Type "B"					Type "C"												
#120	1 1/2"	10	1.24	2.82	5.26	9.81	14.1	18.3	26.4	34.2	41.8	49.2	56.6	63.9	37.9	31.8	27.1	23.5	20.6	16.4	0	0	0		
		11	1.37	3.12	5.83	10.9	15.7	20.3	29.2	37.9	46.3	54.6	62.9	71.2	43.2	36.2	30.9	26.8	23.5	18.7	0	0	0		
		12	1.50	3.43	6.40	11.9	17.2	22.3	32.1	41.6	50.9	59.9	68.8	77.7	48.7	40.8	34.9	30.2	26.5	21.0	0	0	0		
		13	1.64	3.74	6.98	13.0	18.8	24.3	35.0	45.4	55.5	65.3	75.0	84.7	54.4	45.6	39.0	33.8	29.6	23.5	0	0	0		
		14	1.78	4.05	7.56	14.1	20.3	26.3	37.9	49.1	60.1	70.8	81.4	91.9	60.4	50.6	43.2	37.4	32.9	26.1	0	0	—		
		15	1.91	4.37	8.15	15.2	21.9	28.3	40.9	53.0	64.7	76.3	87.8	99.3	66.5	55.7	47.6	41.2	36.2	28.7	0	0	—		
		16	2.05	4.68	8.74	16.3	23.5	30.4	43.8	56.8	69.4	81.8	94.0	106.	118.	66.5	55.7	47.6	41.2	36.2	28.7	0	0	—	
		17	2.19	5.00	9.33	17.4	25.1	32.5	46.8	60.6	74.1	87.3	100.	113.	126.	89.0	72.8	61.0	52.1	45.2	39.6	31.5	0	0	—
		18	2.33	5.32	9.92	18.5	26.7	34.6	49.8	64.5	78.8	92.9	107.	121.	135.	97.0	79.4	66.5	56.8	49.2	43.2	0	0	—	
		19	2.47	5.64	10.5	19.6	28.3	36.6	52.8	68.4	83.6	98.5	113.	128.	143.	105.	86.1	72.1	61.6	53.4	46.8	0	0	—	
		20	2.61	5.96	11.1	20.7	29.9	38.7	55.8	72.7	88.3	104.	120.	136.	152.	114.	92.9	77.9	66.5	57.6	50.6	0	0	—	
		21	2.75	6.28	11.7	21.9	31.5	40.8	58.8	76.2	93.1	110.	127.	144.	161.	122.	100.	83.8	71.6	62.0	54.4	0	0	—	
		22	2.90	6.60	12.3	23.0	33.1	42.9	61.8	80.1	97.9	115.	131.	147.	164.	130.	109.	89.9	76.7	66.5	58.4	0	0	—	
		23	3.04	6.93	12.9	24.1	34.8	45.0	64.9	8															

HORSEPOWER RATINGS - ANSI ROLLER CHAIN

Table No. 1

Chain Size	Pitch	Number of Teeth In Sprocket	Revolutions Per Minute of Small Sprocket																			
			5	10	15	20	30	40	50	70	100	150	200	250	300	350	400	450	500	550	600	650
#200	2 1/2"	9	—	4.54	6.54	8.47	12.2	15.8	19.3	19.6	36.0	51.9	67.3	82.2	96.9	111.	119.	100.	85.4	74.1	65.0	57.6
		10	—	5.08	7.32	9.49	13.7	17.7	21.6	29.3	40.4	58.2	75.4	92.1	109.	125.	140.	117.	100.	86.7	76.1	65.5
		11	—	5.64	8.12	10.5	15.1	19.6	24.0	32.5	44.8	64.5	83.5	102.	120.	138.	156.	135.	115.	100.	87.8	77.9
		12	—	6.19	8.92	11.6	16.6	21.6	26.4	35.7	49.2	70.8	91.8	112.	132.	152.	171.	154.	132.	114.	100.	0
		13	—	6.75	9.72	12.6	18.1	23.5	28.7	38.9	53.6	77.2	100.	122.	144.	166.	187.	174.	148.	129.	113.	0
		14	—	7.31	10.5	13.6	19.7	25.5	31.1	42.1	58.1	83.7	108.	132.	156.	179.	202.	194.	166.	144.	126.	0
		15	—	7.88	11.3	14.7	21.2	27.4	33.5	45.4	62.6	90.1	117.	143.	168.	193.	218.	215.	184.	159.	140.	0
		16	—	8.45	12.2	15.8	22.7	29.4	36.0	48.7	67.1	96.6	125.	153.	180.	207.	234.	237.	203.	176.	154.	0
		17	—	9.02	13.0	16.8	24.2	31.4	38.4	52.0	71.6	103.	134.	163.	193.	221.	249.	260.	222.	192.	169.	0
		18	—	9.59	13.8	17.9	25.8	33.4	40.8	55.3	76.2	110.	142.	174.	205.	235.	265.	283.	242.	209.	184.	0
		19	—	10.2	14.6	19.0	27.3	35.4	43.3	58.6	80.8	116.	151.	184.	217.	249.	281.	307.	262.	227.	199.	0
		20	—	10.7	15.5	20.1	28.9	37.4	45.8	61.9	85.4	123.	159.	195.	229.	264.	297.	331.	283.	245.	0	—
		21	—	11.3	16.3	21.1	30.5	39.5	48.2	65.3	90.0	130.	168.	205.	242.	278.	313.	348.	305.	264.	0	—
		22	—	11.9	17.2	22.2	32.0	41.5	50.7	68.7	94.6	136.	177.	216.	254.	292.	330.	366.	327.	283.	0	—
		23	—	12.5	18.0	23.3	33.6	43.5	53.2	72.0	99.3	143.	185.	226.	267.	307.	346.	384.	349.	303.	0	—
		24	—	13.1	18.9	24.4	35.2	45.6	55.7	75.4	104.	150.	194.	237.	279.	321.	362.	402.	372.	323.	0	—
		25	—	13.7	19.7	25.5	36.8	47.6	58.2	78.8	109.	156.	203.	248.	292.	335.	378.	421.	396.	343.	0	—
		26	—	14.3	20.6	26.6	38.4	49.7	60.7	82.2	113.	163.	212.	259.	305.	350.	395.	439.	420.	364.	0	—
Lubrication			Type "A"					Type "B"					Type "C"									
#240	3"	9	3.92	7.31	10.5	13.6	19.6	25.4	31.1	42.1	58.1	83.6	108.	132.	156.	169.	138.	116.	0	—	—	—
		10	4.39	8.19	11.8	15.3	22.0	28.5	34.9	47.1	65.0	93.7	121.	148.	175.	198.	162.	136.	—	—	—	—
		11	4.86	9.08	13.1	16.9	24.4	31.6	38.6	52.2	72.1	104.	135.	164.	194.	223.	187.	156.	—	—	—	—
		12	5.34	9.97	14.4	18.6	26.8	34.7	42.4	57.4	79.2	114.	148.	181.	213.	245.	218.	0	—	—	—	—
		13	5.83	10.9	15.7	20.3	29.2	37.9	46.3	62.5	86.4	124.	161.	197.	232.	267.	240.	0	—	—	—	—
		14	6.31	11.8	17.0	22.0	31.7	41.0	50.1	67.8	93.6	135.	175.	213.	251.	289.	268.	0	—	—	—	—
		15	6.80	12.7	18.3	23.7	34.1	44.2	54.0	73.0	101.	145.	188.	230.	271.	311.	297.	0	—	—	—	—
		16	7.29	13.6	19.6	25.4	36.6	47.4	57.9	78.3	108.	156.	202.	247.	290.	334.	328.	0	—	—	—	—
		17	7.78	14.5	20.9	27.1	39.0	50.6	61.8	83.6	115.	166.	215.	263.	310.	356.	359.	0	—	—	—	—
		18	8.28	15.4	22.3	28.8	41.5	53.8	65.8	88.7	123.	177.	229.	280.	330.	379.	377.	0	—	—	—	—
		19	8.78	16.4	23.6	30.6	44.0	57.0	69.7	94.1	130.	187.	243.	297.	350.	402.	393.	0	—	—	—	—
		20	9.28	17.3	24.9	32.3	46.5	60.3	73.7	99.4	138.	198.	257.	314.	370.	423.	407.	0	—	—	—	—
		21	9.78	18.2	26.3	34.1	49.0	63.5	77.7	105.	145.	209.	270.	331.	390.	439.	421.	0	—	—	—	—
		22	10.3	19.2	27.6	35.8	51.6	66.8	81.7	110.	152.	220.	284.	348.	410.	454.	435.	0	—	—	—	—
		23	10.8	20.1	29.0	37.6	54.1	70.1	85.7	116.	160.	230.	298.	365.	430.	469.	448.	0	—	—	—	—
		24	11.3	21.1	30.4	39.3	56.7	73.4	89.7	121.	167.	241.	312.	382.	450.	483.	0	—	—	—	—	—
		25	11.8	22.0	31.7	41.1	59.2	76.7	93.8	126.	175.	252.	327.	399.	470.	496.	0	—	—	—	—	—
		26	12.3	23.0	33.1	42.9	61.8	80.0	97.8	132.	183.	263.	341.	416.	491.	509.	0	—	—	—	—	—
Lubrication			Type "A"					Type "B"					Type "C"									

Chain can be rated higher than ratings shown in this catalog for certain applications. Contact Browning with details of the applications.

- Type "A" - Manual or Drip Lubrication.
- Type "B" - Bath or Disc Lubrication.
- Type "C" - Oil Stream Lubrication.

Maximum Chain Speed (FPM) for Types A, B and C Lubrication

Table No. 2

Lubrication	Chain Size													
	25	35	41	40	50	60	80	100	120	140	160	180	200	240
Type "A"	500	370	300	300	250	220	170	150	130	115	100	90	85	75
Type "B"	2500	2800	2300	2300	2000	1800	1500	1300	1200	1100	1000	960	900	800
Type "C"	Maximum shown in Rating Tables													

Capacities listed in the Rating Tables are for Single Strand Standard and Heavy Chain. For other chains multiply the above ratings by the following factors:

Double	Triple	Quadruple	Stainless Steel
1.7	2.5	3.3	.2

Browning® LL Chain may replace standard chain when life is limited due to lack of lubrication, between 0° F. and 200° F. ambient temperature. For either temperatures and for new drives, consult the Browning Engineers.

Interpolate for ratings of sprocket sizes and speeds not shown in tables; for SLOWER SPEEDS, see Page G-55.

CAUTION-Zero values in the tables indicate speeds beyond the maximum recommended. Operation at these speeds results in galling of chain joints, regardless of the volume of lubricant applied. Driver sprockets with 17 or more teeth should be used for moderate speeds and 21 or more teeth should be used for high speeds.

All sales are made on our STANDARD TERMS AND CONDITIONS OF SALE in effect at the time a customer's order is accepted. The current Terms and Conditions are set forth below:

STANDARD TERMS AND CONDITIONS OF SALE (September 2, 2009)

These Terms and Conditions, the attendant quotation or acknowledgment and all documents incorporated by specific reference therein, will be the complete and exclusive statement of the terms of the agreement governing the sale of goods ("Goods") by Emerson Power Transmission Corporation and its divisions and subsidiaries ("Seller") to Customer ("Buyer"). Buyer's acceptance of the Goods will manifest Buyer's assent to these Terms and Conditions. If these Terms and Conditions differ in any way from the terms and conditions of Buyer's order, or other documentation, this document will be construed as a counteroffer and will not be deemed an acceptance of Buyer's terms and conditions which conflict herewith.

1. **PRICES:** Unless otherwise specified in writing by Seller, Seller's price for the goods shall remain in effect for thirty (30) days after the date of Seller's quotation or acknowledgment of Buyer's order for the Goods, whichever occurs first, provided an unconditional, complete authorization for the immediate shipment of the Goods is received and accepted by Seller within such time period. If such authorization is not received by Seller within such thirty (30) day period, Seller shall have the right to change the price for the Good to Seller's price for the Goods at the time of shipment.

2. **TAXES:** Any tax or governmental charge or increase in same hereafter becoming effective increasing the cost to Seller of producing, selling or delivering the Goods or of procuring material used therein, and any tax now in effect or increase in same payable by the Seller because of the manufacture, sale or delivery of the Goods, may at Seller's option, be added to the price.

3. **TERMS OF PAYMENT:** Subject to the approval of Seller's Credit Department, terms are net thirty (30) days from date of Seller's invoice in U.S. currency. If any payment owed to Seller is not paid when due, it shall bear interest, at a rate to be determined by Seller, which shall not exceed the maximum rate permitted by law, from the date on which it is due until it is paid. Seller shall have the right, among other remedies, either to terminate the Agreement or to suspend further performance under this and/or other agreements with Buyer in the event Buyer fails to make any payment when due. Buyer shall be liable for all expenses, including attorneys' fees, relating to the collection of past due amounts.

4. **SHIPMENT AND DELIVERY:** Shipments are made F.O.B. Seller's shipping point. Any claims for shortages or damages suffered in transit shall be submitted by the Buyer directly to the carrier. While Seller will use all reasonable commercial efforts to maintain the delivery date acknowledged or quoted by Seller, all shipping dates are approximate. Seller reserves the right to make partial shipments and to segregate "specials" and made-to-order Goods from normal stock Goods. Seller shall not be bound to tender delivery of any Goods for which Buyer has not provided shipping instructions.

5. **QUANTITY:** Buyer agrees to accept overruns of up to ten percent (10%) of the order on "made-to-order" Goods, including parts. Any such additional items shall be priced at the price per item charged for the specific quantity ordered.

6. **LIMITED WARRANTY:** Subject to the limitations of Section 7, Seller warrants that the Goods will be free from defects in material and workmanship under normal use, service and maintenance for a period of one year (unless otherwise specified by Seller in writing) from the date of shipment of the Goods by Seller. **THIS IS THE SOLE AND EXCLUSIVE WARRANTY GIVEN BY SELLER WITH RESPECT TO THE GOODS AND IS IN LIEU OF AND EXCLUDES ALL OTHER WARRANTIES, EXPRESS OR IMPLIED, ARISING BY OPERATION OF LAW OR OTHERWISE, INCLUDING WITHOUT LIMITATION, MERCHANTABILITY OR FITNESS FOR A PARTICULAR PURPOSE WHETHER OR NOT THE PURPOSE OR USE HAS BEEN DISCLOSED TO SELLER IN SPECIFICATIONS, DRAWINGS OR OTHERWISE, AND WHETHER OR NOT SELLER'S PRODUCTS ARE SPECIFICALLY DESIGNED AND/OR MANUFACTURED BY SELLER FOR BUYER'S USE OR PURPOSE.**

This warranty does not extend to any losses or damages due to misuse, accident, abuse, neglect, normal wear and tear, unauthorized modification or alteration, use beyond rated capacity, or improper installation, maintenance or application. To the extent that Buyer or its agents has supplied specifications, information, representation of operating conditions or other data to Seller in the selection or design of the Goods and the preparation of Seller's quotation, and in the event that actual operating conditions or other conditions differ from those represented by Buyer, any warranties or other provisions contained herein which are affected by such conditions shall be null and void. If within thirty (30) days after Buyer's discovery of any warranty defects within the warranty period, Buyer notifies Seller thereof in writing, Seller shall, at its option, repair or replace F.O.B. point of manufacture, or refund the purchase price for that portion of the goods found by Seller to be defective. Failure by Buyer to give such written notice within the applicable time period shall be deemed an absolute and unconditional waiver of Buyer's claim for such defects. Goods repaired or replaced during the warranty period shall be covered by the foregoing warranty for the remainder of the original warranty period or ninety (90) days, whichever is longer. Buyer assumes all other responsibility for any loss, damage, or injury to persons or property arising out of, connected with, or resulting from the use of Goods, either alone or in combination with other products/components.

SECTIONS 6 AND 7 APPLY TO ANY ENTITY OR PERSON WHO MAY BUY, ACQUIRE OR USE SELLER'S GOODS, INCLUDING ANY ENTITY OR PERSON WHO BUYS THE GOODS FROM SELLER'S DISTRIBUTOR AND SUCH ENTITY OR PERSON SHALL BE BOUND BY THE LIMITATIONS THEREIN.

7. **LIMITATION OF REMEDY AND LIABILITY: THE SOLE AND EXCLUSIVE REMEDY FOR BREACH OF ANY WARRANTY HEREUNDER (OTHER THAN THE WARRANTY PROVIDED UNDER SECTION 13) SHALL BE LIMITED TO REPAIR, REPLACEMENT OR REFUND OF THE PURCHASE PRICE UNDER SECTION 6. SELLER SHALL NOT BE LIABLE FOR DAMAGES CAUSED BY DELAY IN PERFORMANCE AND IN NO EVENT, REGARDLESS OF THE FORM OF THE CLAIM OR CAUSE OF ACTION (WHETHER BASED IN CONTRACT, INFRINGEMENT, NEGLIGENCE, STRICT LIABILITY, OTHER TORT OR OTHERWISE), SHALL SELLER'S LIABILITY TO BUYER AND/OR ITS CUSTOMERS EXCEED THE PRICE TO BUYER OF THE SPECIFIC GOODS PROVIDED BY SELLER GIVING RISE TO THE CLAIM OR CAUSE OF ACTION. BUYER AGREES THAT IN NO EVENT SHALL SELLER'S LIABILITY TO BUYER AND/OR ITS CUSTOMERS EXTEND TO INCLUDE INCIDENTAL, CONSEQUENTIAL OR PUNITIVE DAMAGES. THE TERM "CONSEQUENTIAL DAMAGES" SHALL INCLUDE, BUT NOT BE LIMITED TO, LOSS OF ANTICIPATED PROFITS, LOSS OF USE, LOSS OF REVENUE, COST OF CAPITAL AND DAMAGE OR LOSS OF OTHER PROPERTY OR EQUIPMENT.**

It is expressly understood that any technical advice furnished by Seller with respect to the use of the Goods is given without charge, and Seller assumes no obligation or liability for the

advice given, or results obtained, all such advice being given and accepted at Buyer's risk. **GOODS AND/OR SERVICES SOLD HEREUNDER ARE NOT FOR USE IN ANY NUCLEAR AND RELATED APPLICATIONS.** Buyer accepts goods and/or services with the foregoing understanding, agrees to communicate the same in writing to any subsequent purchaser or users and to defend, indemnify and hold harmless Seller from any claims, losses, suits, judgments and damages, including incidental and consequential damages, arising from such use, whether the cause of action be based in tort, contract or otherwise, including allegations that the Seller's liability is based on negligence or strict liability.

8. **EXCUSE OF PERFORMANCE:** Seller shall not be liable for delays in performance or for non-performance due to acts of God, acts of Buyer, war, riot, fire, flood, other severe weather, sabotage, or epidemics; strikes or labor disturbances; governmental requests, restrictions, laws, regulations, orders or actions; unavailability of or delays in transportation; default of suppliers; or unforeseen circumstances or any events or causes beyond Seller's reasonable control. Deliveries may be suspended for an appropriate period of time as a result of the foregoing. If Seller determines that its ability to supply the total demand for the Goods, or to obtain material used directly or indirectly in the manufacture of the Goods, is hindered, limited or made impracticable due to causes addressed in this Section 8, Seller may allocate its available supply of the Goods or such material (without obligation to acquire other supplies of any such Goods or material) among itself and its purchasers on such basis as Seller determines to be equitable without liability for any failure of performance which may result therefrom. Deliveries suspended or not made by reason of this section may be canceled by Seller upon notice to Buyer without liability, but the balance of the agreement shall otherwise remain unaffected.

9. **CANCELLATIONS AND DELAYS:** The Buyer may cancel orders only upon written notice and upon payment to Seller of cancellation charges which include, among other things, all costs and expenses incurred and commitments made by the Seller and a reasonable profit thereon. Any request by Buyer to extend the delivery schedule must be agreed to in writing by the Seller. If agreement cannot be reached, Seller may deliver product to the last known ship to address and invoice the Buyer upon completion of the product or prior delivery date, whichever is later.

10. **CHANGES:** Buyer may request changes or additions to the Goods consistent with Seller's specifications and criteria. In the event such changes or additions are accepted by Seller, Seller may revise the price and delivery schedule. Seller reserves the right to change designs and specifications for the Goods without prior notice to Buyer, except with respect to Goods being made-to-order for Buyer.

11. **TOOLING:** Tool, die, and pattern charges, if any, are in addition to the price of the Goods and are due and payable upon completion of the tooling. All such tools, dies and patterns shall be and remain the property of Seller. Charges for tools, dies, and patterns do not convey to Buyer, title, ownership interests in, or rights to possession or removal, nor prevent their use by Seller for other purchasers, except as otherwise expressly provided by Seller and Buyer in writing with reference to this provision.

12. **ASSIGNMENT:** Buyer shall not assign its rights or delegate its duties hereunder or any interest therein or any rights hereunder without the prior written consent of the Seller, and any such assignment, without such consent, shall be void.

13. **PATENTS AND COPYRIGHTS:** Subject to Section 7, Seller warrants that the Goods sold, except as are made specifically for Buyer according to Buyer's specifications, do not infringe any valid U.S. patent or copyright in existence as of the date of delivery. This warranty is given upon the condition that Buyer promptly notify Seller of any claim or suit involving Buyer in which such infringement is alleged, and, that Buyer cooperate fully with Seller and permit Seller to control completely the defense or compromise of any such allegation of infringement. Seller's warranty as to use only applies to infringements arising solely out of the inherent operation (i) of such Goods, or (ii) of any combination of Goods in a system designed by Seller. In the event such Goods, singularly or in combination, are held to infringe a U.S. patent or copyright in such suit, and the use of such Goods is enjoined, or in the case of a compromise by Seller, Seller shall have the right, at its option and expense, to procure for Buyer the right to continue using such Goods, or replace them with non-infringing Goods; or modify same to become non-infringing; or grant Buyer a credit for the depreciated value of such Goods and accept return of them.

14. **MISCELLANEOUS:** These terms and conditions set forth the entire understanding and agreement between Seller and Buyer, and supersede all other communications, negotiations and prior oral or written statements regarding the subject matter of these terms and conditions. No change, modification, rescission, discharge, abandonment, or waiver of these terms and conditions of Sale shall be binding upon the Seller unless made in writing and signed on its behalf by an officer of the Seller. No conditions, usage or trade, course of dealing or performance, understanding or agreement purporting to modify, vary, explain, or supplement these Terms and Conditions shall be binding unless hereafter made in writing and signed by the party to be bound, and no modification shall be affected by the acceptance of purchase orders or shipping instruction forms containing terms at variance with or in addition to those set forth herein. Any such modifications or additional terms are specifically rejected by Seller. No waiver by Seller with respect to any breach or default or any right or remedy and no course of dealing, shall be deemed to constitute a continuing waiver of any other breach or default or of any other right or remedy, unless such waiver be expressed in writing and signed by the party to be bound. Seller is not responsible for typographical or clerical errors made in any quotation, orders or publications. All such errors are subject to correction. The validity, performance, and all other matters relating to the interpretation and effect of this contract shall be governed by the law of the state of New York. The United Nations Convention on the International Sale of Goods shall not apply to any transaction hereunder.